

THDB-HTG

User Manual

Terasic HSTC to GPIO Daughter Board

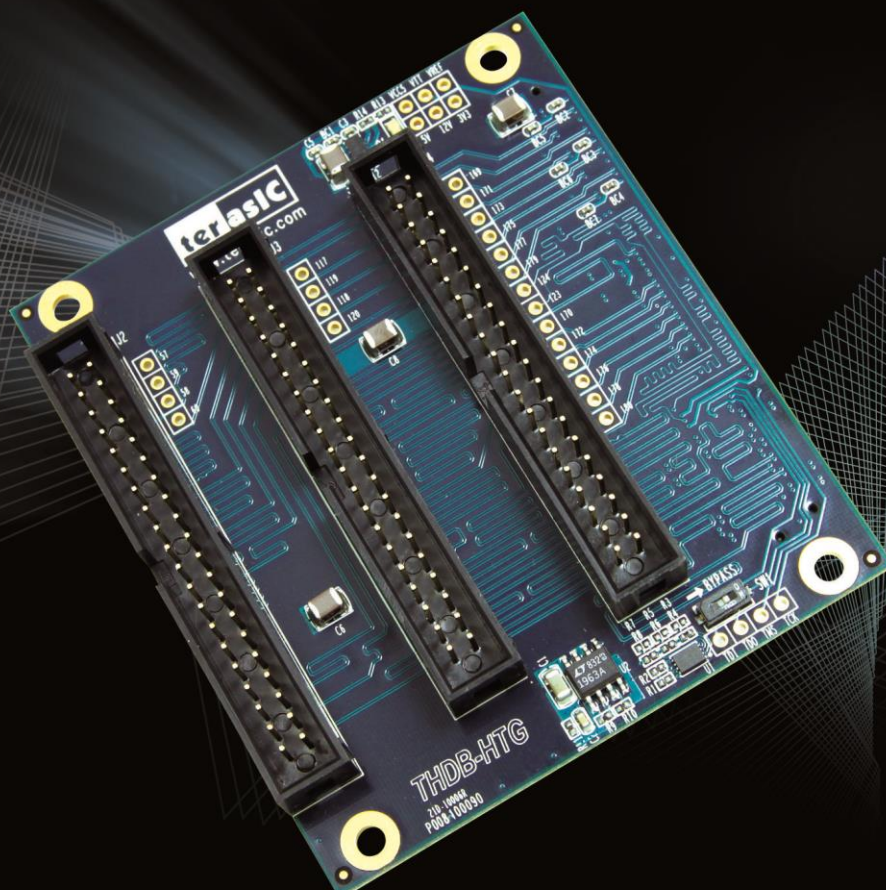

INTRODUCTION	1
1-1 FEATURES.....	1
1-2 GETTING HELP	1
ARCHITECTURE	2
1-3 LAYOUT AND COMPONENTS.....	2
1-4 BLOCK DIAGRAM	4
BOARD COMPONENTS	5
1-5 HSTC/HSMC EXPANSION CONNECTOR.....	5
1-6 EXPANSION PROTOTYPE CONNECTORS	7
1-7 CYCLONE III STARTER BOARD HSMC CONNECTOR.....	12
1-8 PROTOTYPING AREA	12
1-9 JTAG SWITCH.....	13
1-10 POWER ON CONTROL PIN.....	14
1-11 I2C SERIAL EEPROM	14
1-12 POWER SUPPLY	15
DEMONSTRATION	16
1-13 CONNECTING THDB-HTG BOARD TO A CYCLONE III STARTER BOARD	16
1-14 CONNECTING THDB-HTG BOARD TO ALTERA DE3 BOARD	17
APPENDIX	18
1-15 REVISION HISTORY	18
1-16 ALWAYS VISIT THDB-HTG WEBPAGE FOR NEW MAIN BOARD	18

The THDB-HTG board is designed to convert a High-Speed Terasic connector (HSTC) or a High-Speed Mezzanine connector (HSMC) I/Os to three 40-pin expansion prototype connectors, which are compatible with Terasic GPIO expansion headers. Users can connect up to three Altera DE2/DE1 boards (or associated daughter cards) onto a HSTC/HSMC-interfaced host board via a THDB-HTG board.

Features

Figure 1.1 shows the photo of a THDB-HTG board. The important functions of the THDB-HTG are listed below:

- Convert HSTC/HSMC-interfaced I/O to standard 40-pin expansion connectors.
- Allow users to connect Altera DE2/DE1 boards to a HSTC/HSMC-interfaced host board.
- Provide test points for signal measurement.

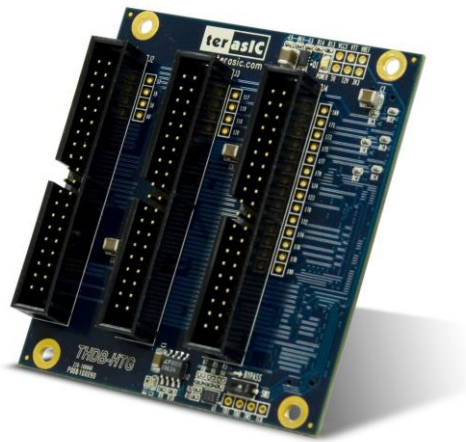

Figure 1.1. The picture of a THDB-HTG board

Getting Help

Here are some places to get help if you encounter any problem:

- ✓ Email to support@terasic.com
- ✓ Taiwan & China: +886-3-550-8800
- ✓ Korea : +82-2-512-7661
- ✓ English Support Line: +1-408-512-12336

This chapter describes the architecture of the THDB-HTG board, including block diagram and components.

Layout and Componets

Figure 2.1, Figure 2.2, and Figure 2.3 depict the layout of the board and indicate the locations of the connectors and key components.

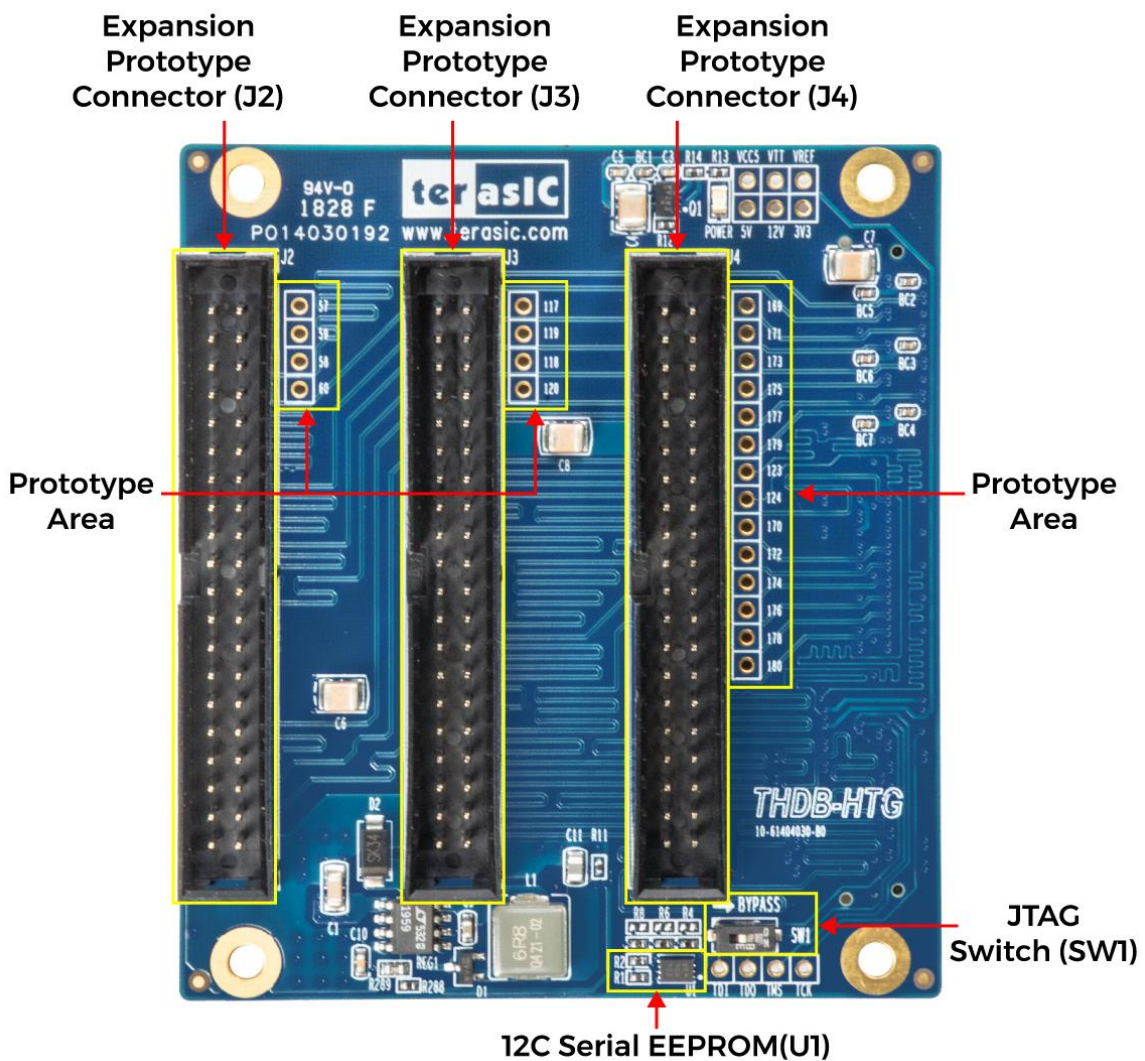

Figure 2.1 Top view of the TDRB-HTG board

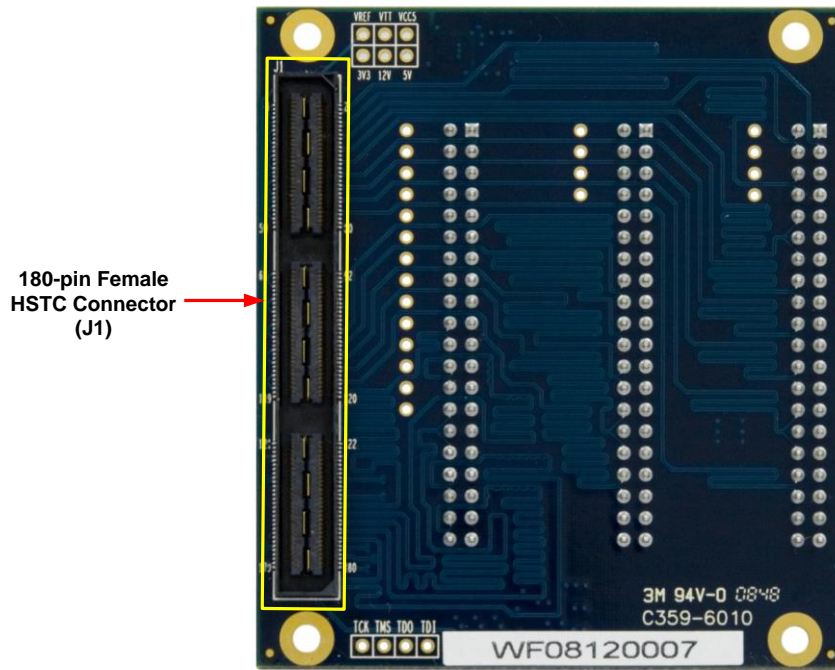

Figure 2.2 Back side of the TDRB-HTG board – HSTC version

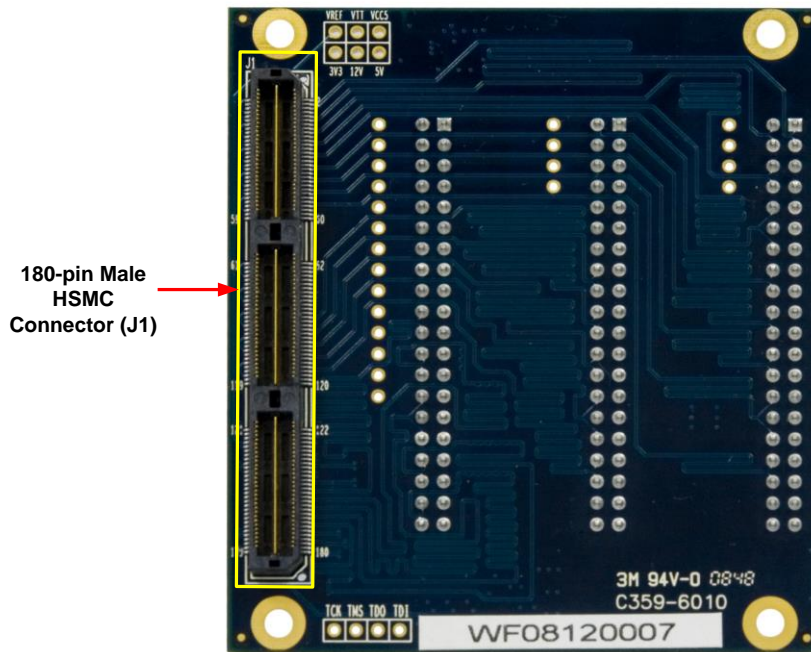

Figure 2.3 Back side of the TDRB-HTG board – HSMC version

The following components are provided on the THDB-HTG board :

- HSTC/HSMC expansion connector (J1)
- Expansion prototype connectors (J2,J3,J4)
- I2C serial EEPROM (U1)

Block Diagram

Figure 2.4 shows the block diagram of the THDB-HTG board.

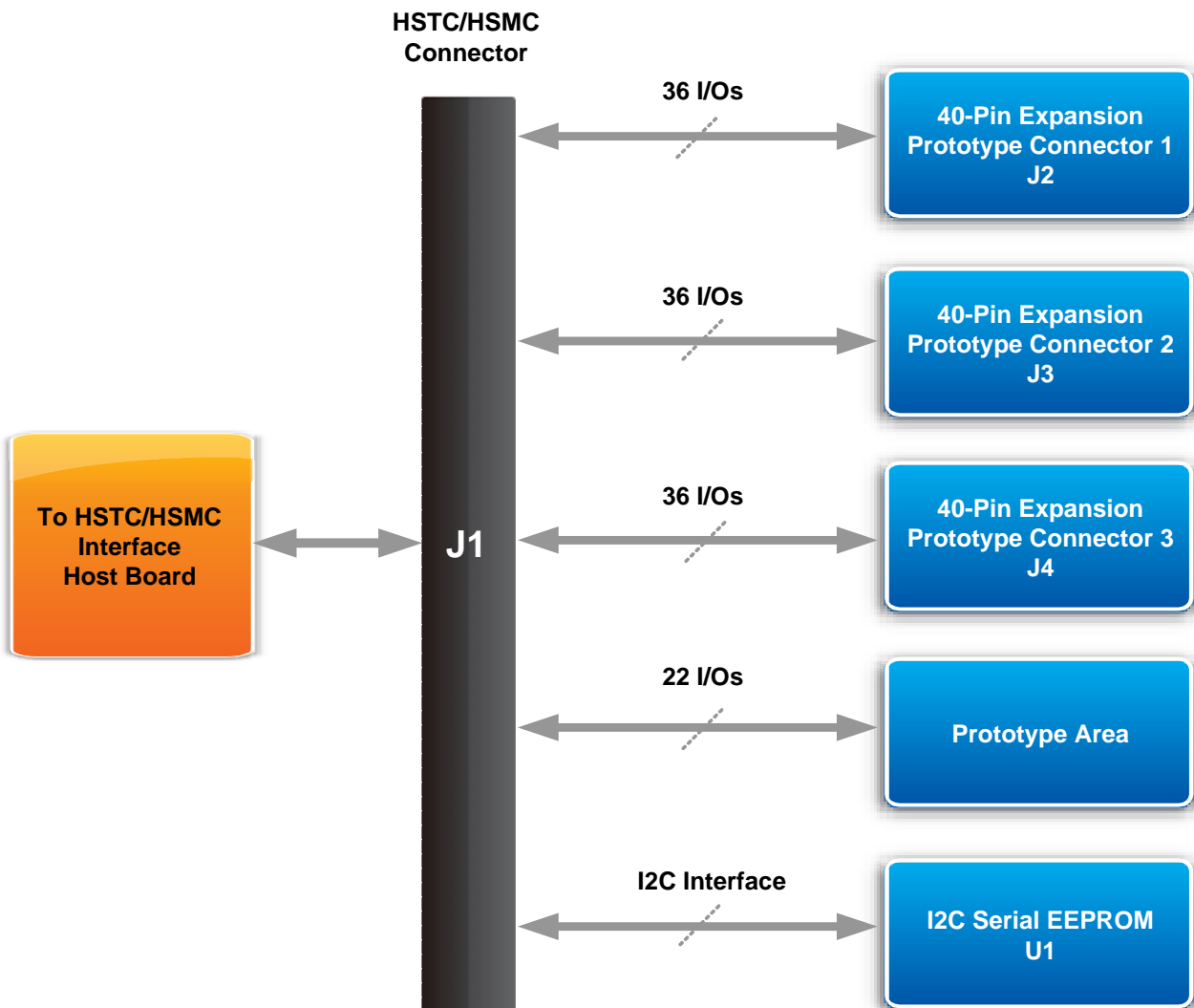

Figure 2.4. The block diagram of the THDB-HTG board

CHAPTER

3 Board Components



www.terasic.com

This section will describe the information of components, connector interfaces, and pin mappings on the THDB-HTG board in details.

HSTC/HSMC Expansion Connector

This section describes the HSTC/HSMC connector on the THDB-HTG board

There are two options of high speed connector on the THDB-HTG board. One is a 180-pin female HSTC connector for HSTC-interfaced host board such as Altera DE3 board and Terasic PCI board. The other one is a 180-pin male connector for Altera HSMC-interfaced host board. All other interfaces on the THDB-HTG board are connected to the HSTC/HSMC connector. Figure 3.1 shows the pin-outs of the HSTC and HSMC connector.



Figure 3.1 The pin-outs of the HSTC and HSMC connector.

Expansion Prototype Connectors

This section describes the expansion prototype connectors on the THDB-HTG board.

The THDB-HTG board has three expansion prototype connectors (J2, J3, and J4) connected to the HSTC/HSMC connector directly. Each of the connectors has 36 prototyping I/Os and 3.3/5 volts power supply from the HSTC/HSMC interface and on-board regulator. Users can connect FPGA development kits which has GPIO connector or custom daughter boards to a HSTC/HSMC-interfaced host board. Figure 3.2 and Figure 3.3 show the pin-outs of the expansion prototype connectors for HSTC and HSMC version, respectively. Detailed pin mappings to HSTC/HSMC connector are listed in Table 3.1, Table 3.2, and Table 3.3. **Note that, If users connect THDB-HTG to HSMC-interfaced host board, J4 connector can only be connected to transceiver I/O of FPGA and no other basic I/O available.**

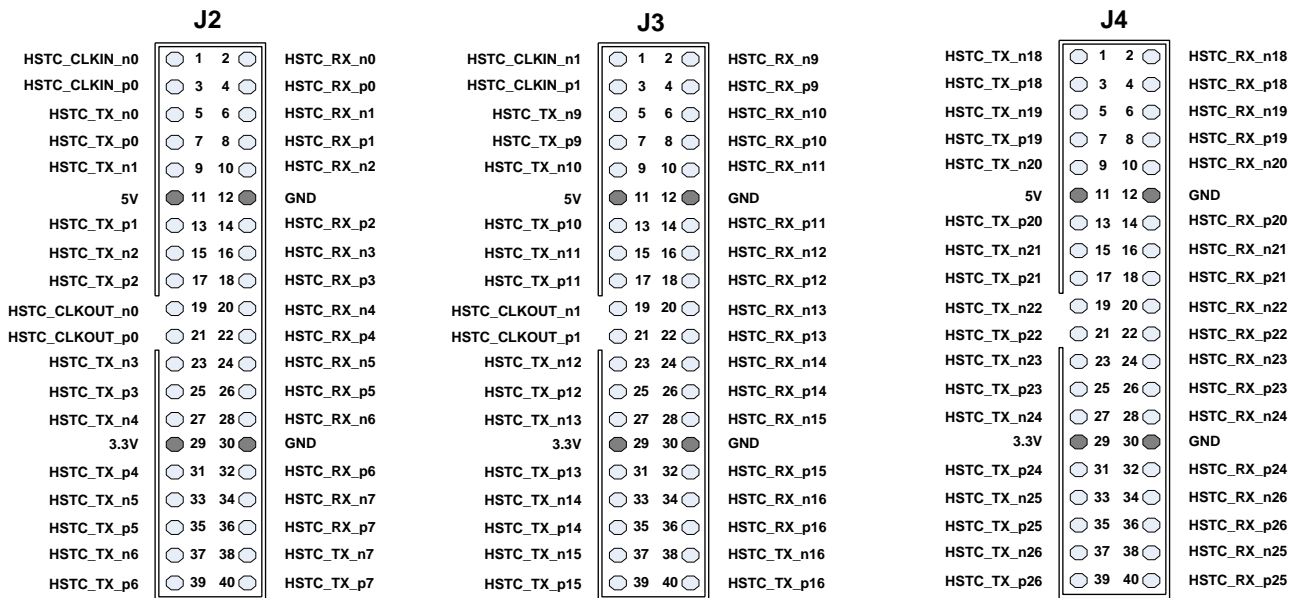

Figure 3.2 Pin-outs of the expansion prototype connectors for HSTC version

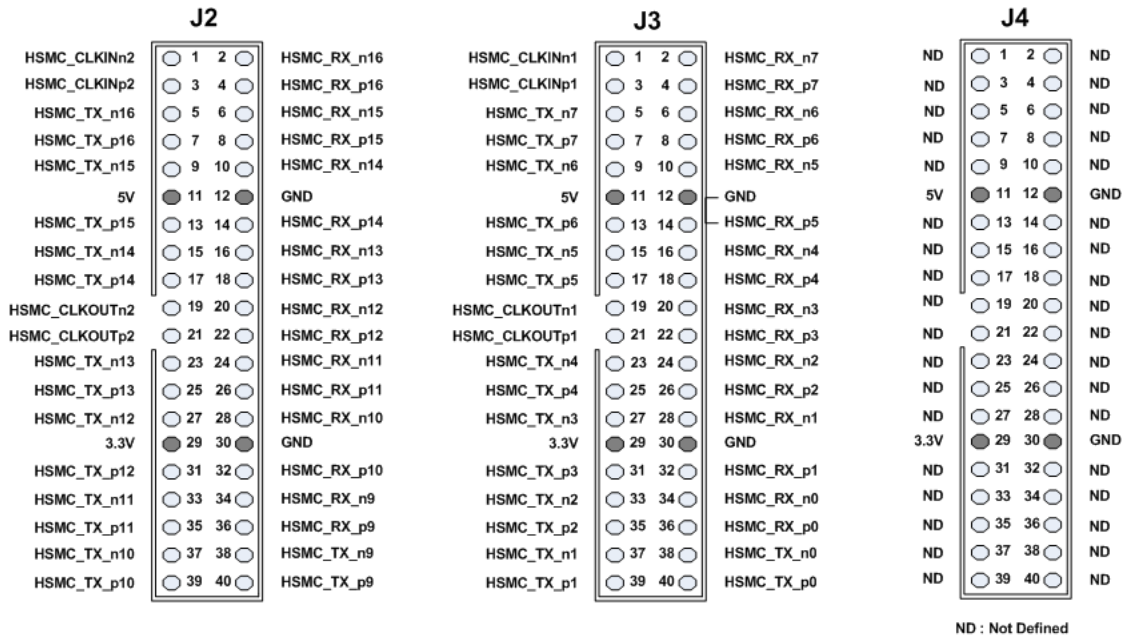

Figure 3.3 Pin-outs of the expansion prototype connectors for HSMC version

Table 3.1 Pin mappings of the expansion prototype connector J2

Expansion Prototype Connector 1 – J2				
J2 Pin Number	J1 Pin Number	J1 (HSTC Version) Signal Name	J1 (HSMC Version) Signal Name	GPIO Signal Name
1	4	HSTC_CLKIN_n0	HSMC_CLKIN_n2	GPIO0
2	10	HSTC_RX_n0	HSMC_RX_n16	GPIO1
3	6	HSTC_CLKIN_p0	HSMC_CLKIN_p2	GPIO2
4	12	HSTC_RX_p0	HSMC_RX_p16	GPIO3
5	9	HSTC_TX_n0	HSMC_TX_n16	GPIO4
6	16	HSTC_RX_n1	HSMC_RX_n15	GPIO5
7	11	HSTC_TX_p0	HSMC_TX_p16	GPIO6
8	18	HSTC_RX_p1	HSMC_RX_p15	GPIO7
9	15	HSTC_TX_n1	HSMC_TX_n15	GPIO8
10	22	HSTC_RX_n2	HSMC_RX_n14	GPIO9
11	N/A	N/A	N/A	5V
12	N/A	N/A	N/A	GND
13	17	HSTC_TX_p1	HSMC_TX_p15	GPIO10
14	24	HSTC_RX_p2	HSMC_RX_p14	GPIO11
15	21	HSTC_TX_n2	HSMC_TX_n14	GPIO12
16	28	HSTC_RX_n3	HSMC_RX_n13	GPIO13
17	23	HSTC_TX_p2	HSMC_TX_p14	GPIO14
18	30	HSTC_RX_p3	HSMC_RX_p13	GPIO15
19	3	HSTC_CLKOUT_n0	HSMC_CLKOUT_n2	GPIO16
20	34	HSTC_RX_n4	HSMC_RX_n12	GPIO17
21	5	HSTC_CLKOUT_p0	HSMC_CLKOUT_p2	GPIO18
22	36	HSTC_RX_p4	HSMC_RX_p12	GPIO19
23	27	HSTC_TX_n3	HSMC_TX_n13	GPIO20
24	40	HSTC_RX_n5	HSMC_RX_n11	GPIO21
25	29	HSTC_TX_p3	HSMC_TX_p13	GPIO22
26	42	HSTC_RX_p5	HSMC_RX_p11	GPIO23
27	33	HSTC_TX_n4	HSMC_TX_n12	GPIO24
28	46	HSTC_RX_n6	HSMC_RX_n10	GPIO25
29	N/A	N/A	N/A	3.3V
30	N/A	N/A	N/A	GND
31	35	HSTC_TX_p4	HSMC_TX_p12	GPIO26
32	48	HSTC_RX_p6	HSMC_RX_p10	GPIO27
33	39	HSTC_TX_n5	HSMC_TX_n11	GPIO28
34	52	HSTC_RX_n7	HSMC_RX_n9	GPIO29
35	41	HSTC_TX_p5	HSMC_TX_p11	GPIO30
36	54	HSTC_RX_p7	HSMC_RX_p9	GPIO31
37	45	HSTC_TX_n6	HSMC_TX_n10	GPIO32
38	51	HSTC_TX_n7	HSMC_TX_n9	GPIO33
39	47	HSTC_TX_p6	HSMC_TX_p10	GPIO34
40	53	HSTC_TX_p7	HSMC_TX_p9	GPIO35

Table 3.2 Pin mappings of the expansion prototype connector J3

Expansion Prototype Connector 1 – J3				
J3 Pin Number	J1 Pin Number	J1 (HSTC Version) Signal Name	J1 (HSMC Version) Signal Name	GPIO Signal Name
1	64	HSTC_CLKIN_n1	HSMC_CLKIN_n1	GPIO0
2	70	HSTC_RX_n9	HSMC_RX_n7	GPIO1
3	66	HSTC_CLKIN_p1	HSMC_CLKIN_p1	GPIO2
4	72	HSTC_RX_p9	HSMC_RX_p7	GPIO3
5	69	HSTC_TX_n9	HSMC_TX_n7	GPIO4
6	76	HSTC_RX_n10	HSMC_RX_n6	GPIO5
7	71	HSTC_TX_p9	HSMC_TX_p7	GPIO6
8	78	HSTC_RX_p10	HSMC_RX_p6	GPIO7
9	75	HSTC_TX_n10	HSMC_TX_n6	GPIO8
10	82	HSTC_RX_n11	HSMC_RX_n5	GPIO9
11	N/A	N/A	N/A	5V
12	N/A	N/A	N/A	GND
13	77	HSTC_TX_p10	HSMC_TX_p6	GPIO10
14	84	HSTC_RX_p11	HSMC_RX_p5	GPIO11
15	81	HSTC_TX_n11	HSMC_TX_n5	GPIO12
16	88	HSTC_RX_n12	HSMC_RX_n4	GPIO13
17	83	HSTC_TX_p11	HSMC_TX_p5	GPIO14
18	90	HSTC_RX_p12	HSMC_RX_p4	GPIO15
19	63	HSTC_CLKOUT_n1	HSMC_CLKOUT_n1	GPIO16
20	94	HSTC_RX_n13	HSMC_RX_n3	GPIO17
21	65	HSTC_CLKOUT_p1	HSMC_CLKOUT_p1	GPIO18
22	96	HSTC_RX_p13	HSMC_RX_p3	GPIO19
23	87	HSTC_TX_n12	HSMC_TX_n4	GPIO20
24	100	HSTC_RX_n14	HSMC_RX_n2	GPIO21
25	89	HSTC_TX_p12	HSMC_TX_p4	GPIO22
26	102	HSTC_RX_p14	HSMC_RX_p2	GPIO23
27	93	HSTC_TX_n13	HSMC_TX_n3	GPIO24
28	106	HSTC_RX_n15	HSMC_RX_n1	GPIO25
29	N/A	N/A	N/A	3.3V
30	N/A	N/A	N/A	GND
31	95	HSTC_TX_p13	HSMC_TX_p3	GPIO26
32	108	HSTC_RX_p15	HSMC_RX_p1	GPIO27
33	99	HSTC_TX_n14	HSMC_TX_n2	GPIO28
34	112	HSTC_RX_n16	HSMC_RX_n0	GPIO29
35	101	HSTC_TX_p14	HSMC_TX_p2	GPIO30
36	114	HSTC_RX_p16	HSMC_RX_p0	GPIO31
37	105	HSTC_TX_n15	HSMC_TX_n1	GPIO32
38	111	HSTC_TX_n16	HSMC_TX_n0	GPIO33
39	107	HSTC_TX_p15	HSMC_TX_p1	GPIO34
40	113	HSTC_TX_p16	HSMC_TX_p0	GPIO35

Table 3.3 Pin mappings of the expansion prototype connector J4

Expansion Prototype Connector 1 – J4 (Only can be used on HSTC version)				
J4 Pin Number	J1 Pin Number	J1 (HSTC Version) Signal Name	J1 (HSMC Version) Signal Name	GPIO Signal Name
1	133	HSTC_TX_n18	ND	GPIO0
2	134	HSTC_RX_n18	ND	GPIO1
3	135	HSTC_TX_p18	ND	GPIO2
4	136	HSTC_RX_p18	ND	GPIO3
5	137	HSTC_TX_n19	ND	GPIO4
6	138	HSTC_RX_n19	ND	GPIO5
7	139	HSTC_TX_p19	ND	GPIO6
8	140	HSTC_RX_p19	ND	GPIO7
9	141	HSTC_TX_n20	ND	GPIO8
10	142	HSTC_RX_n20	ND	GPIO9
11	N/A	N/A	ND	5V
12	N/A	N/A	ND	GND
13	143	HSTC_TX_p20	ND	GPIO10
14	144	HSTC_RX_p20	ND	GPIO11
15	145	HSTC_TX_n21	ND	GPIO12
16	146	HSTC_RX_n21	ND	GPIO13
17	147	HSTC_TX_p21	ND	GPIO14
18	148	HSTC_RX_p21	ND	GPIO15
19	149	HSTC_TX_n22	ND	GPIO16
20	150	HSTC_RX_n22	ND	GPIO17
21	151	HSTC_TX_p22	ND	GPIO18
22	152	HSTC_RX_p22	ND	GPIO19
23	153	HSTC_TX_n23	ND	GPIO20
24	154	HSTC_RX_n23	ND	GPIO21
25	155	HSTC_TX_p23	ND	GPIO22
26	156	HSTC_RX_p23	ND	GPIO23
27	157	HSTC_TX_n24	ND	GPIO24
28	158	HSTC_RX_n24	ND	GPIO25
29	N/A	N/A	ND	3.3V
30	N/A	N/A	ND	GND
31	159	HSTC_TX_p24	ND	GPIO26
32	160	HSTC_RX_p24	ND	GPIO27
33	161	HSTC_TX_n25	ND	GPIO28
34	166	HSTC_RX_n26	ND	GPIO29
35	163	HSTC_TX_p25	ND	GPIO30
36	168	HSTC_RX_p26	ND	GPIO31
37	165	HSTC_TX_n26	ND	GPIO32
38	162	HSTC_TX_n25	ND	GPIO33
39	167	HSTC_TX_p26	ND	GPIO34
40	164	HSTC_TX_p25	ND	GPIO35

Cyclone III Starter Board HSMC Connector

The naming convention used to assign the pin names for the HSMC connector is different for the Cyclone III Starter Board and the standard HSMC connector. Figure 3.4 shows the pin-outs of the expansion prototype connectors for Cyclone III Starter board HSMC version.

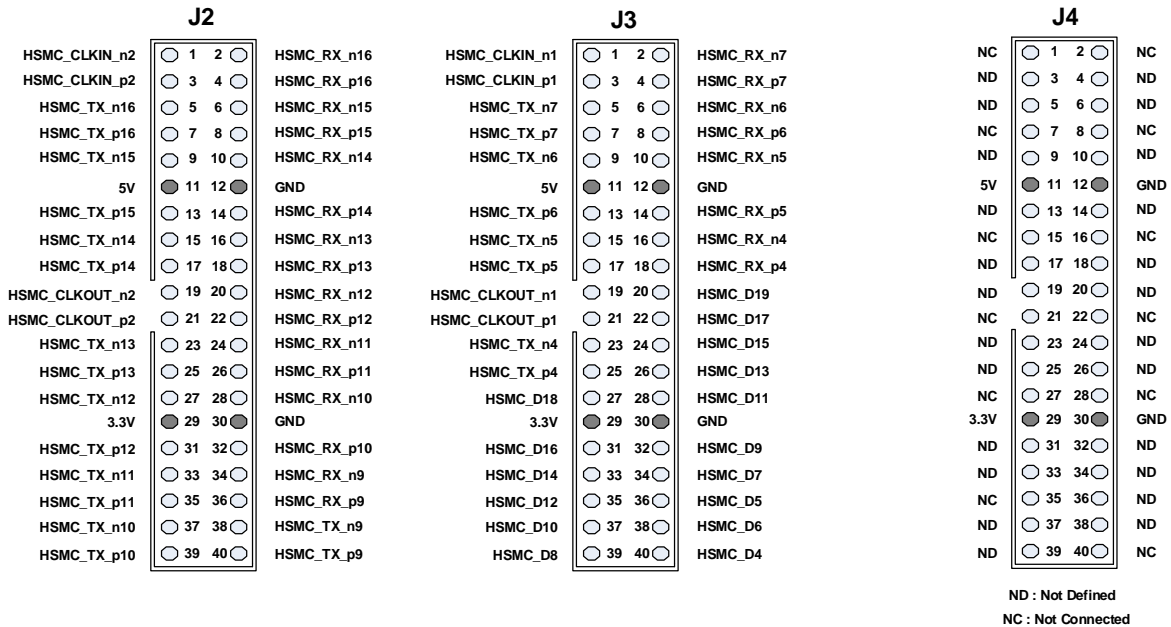

Figure 3.4 Pin-outs of the expansion prototype connectors for Cyclone III Starter board HSMC version

Prototyping Area

The THDB-HTG board provides users a prototyping area for signal measurement or debug. These prototyping points are connected to the HSTC/HSMC connector directly. Detailed I/O maps for HSTC and HSMC version are provided to help users locate the corresponding prototyping points, as shown in Figure 3.4 and Figures 3.5, respectively.

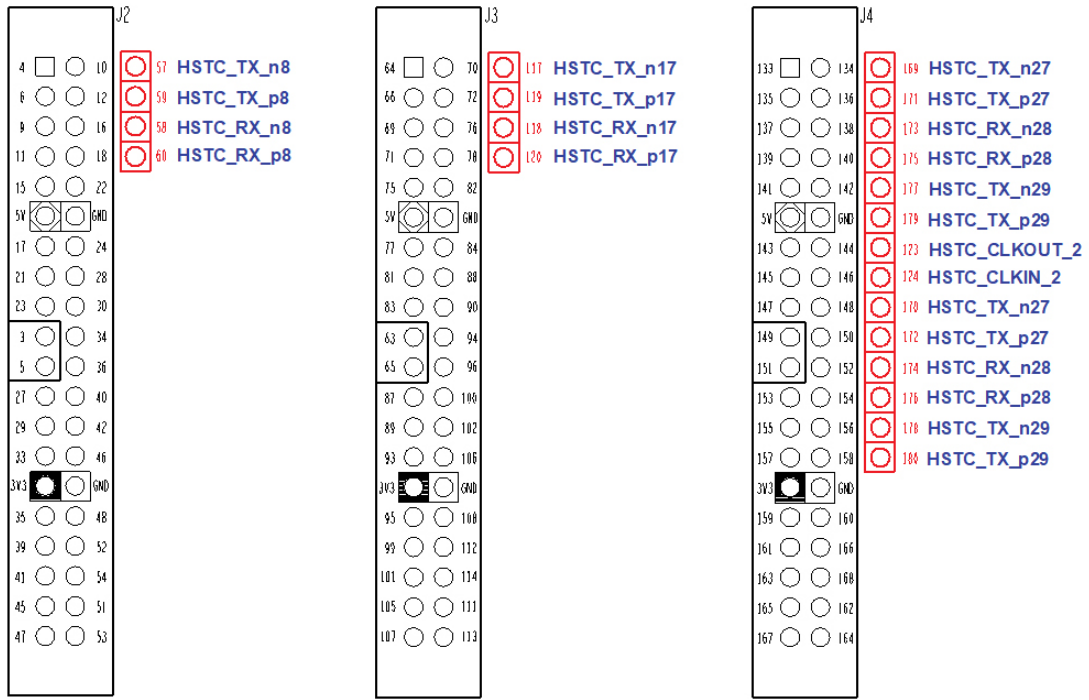

Figure 3.4 Pin distribution of the prototype area for TDHB-HTG HSTC version

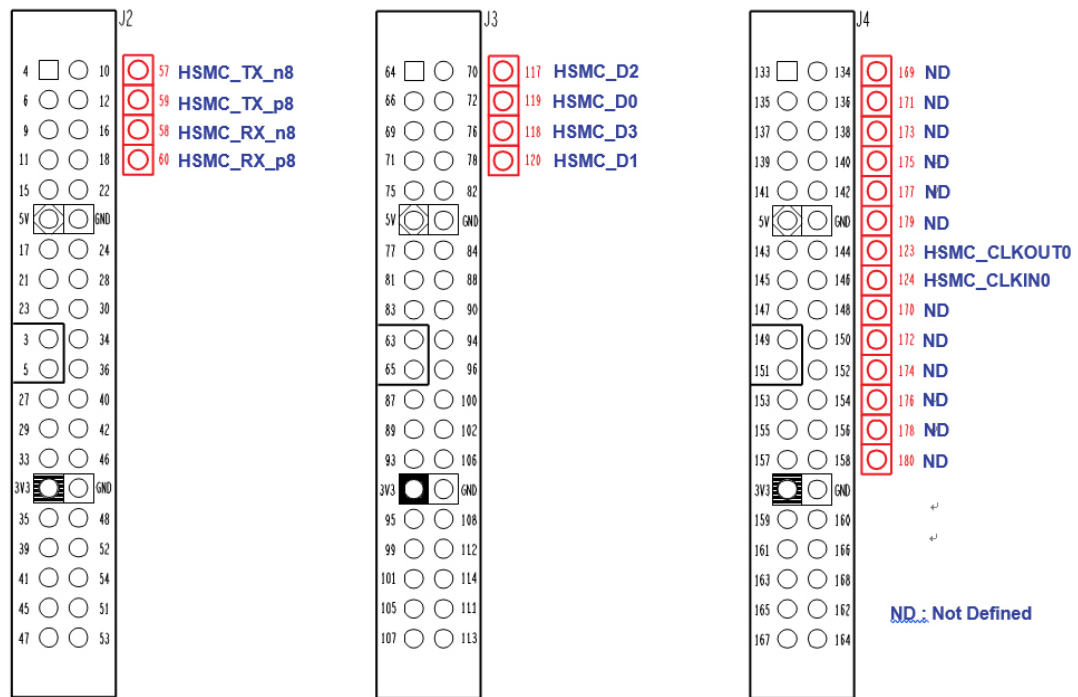

Figure 3.5 Pin distribution of the prototype area for TDHB-HTG HSMC version

JTAG Switch

The THDB-HTG board provides a JTAG switch (SW1) to short the JTAG signal “HSTC_TDI” and “HSTC_TDO” together. When the THDB-HTG board is connected to a HSTC host board, this feature can bypass the JTAG signal from host board to form a close loop of JTAG chain. For example, if users connect a

THDB-HTG with Altera DE3 board, this switch must be turned on, or the Stratix III FPGA device will not be detected because the JTGA chain is not a close loop on DE3 board. Figure 3.6 shows the JTAG switch being turned on.

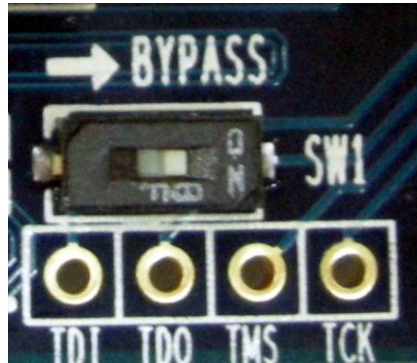

Figure 3.6 The JTAG Switch in “ON” position

Power ON Control Pin

Pin 121 of the HSTC connector is defined as a “Power ON” control signal. This signal allows host board to turn on/off the power supply on THDB-HTG board. When the Power ON signal is in logic low level, the 3.3V and 5V on the expansion header will not supply any power. This feature is designed for THDB-HTG HSTC version only.

I2C Serial EEPROM

This section describes the I2C Serial EEPROM on the THDB-HTG board

The THDB-HTG board provides a Microchip 24LC02BT EEPROM (U1) which can be configured by the I2C interface. The size of the EEPROM is 2K-bit that can store the board information or user’s data. The detailed pin description between EEPROM and HSMC connector is listed in the Table 3.4.

Table 3.4 The pin assignments of the I2C serial EEPROM

EEPROM Pin Number	EPPROM Signal Name	HSMC Pin Number
U1-1	A0	N/A
U1-2	A1	N/A
U1-3	A2	N/A
U1-4	GND	N/A
U1-5	HSTC_SDA	J1-131
U1-6	HSTC_SCL	J1-132
U1-7	WP	N/A
U1-8	VCC33 (3.3 volts)	N/A

Power Supply

This section describes the power supply on the THDB-HTG board.

The power distribution on the THDB-HTG board is shown in Figure 3.7.

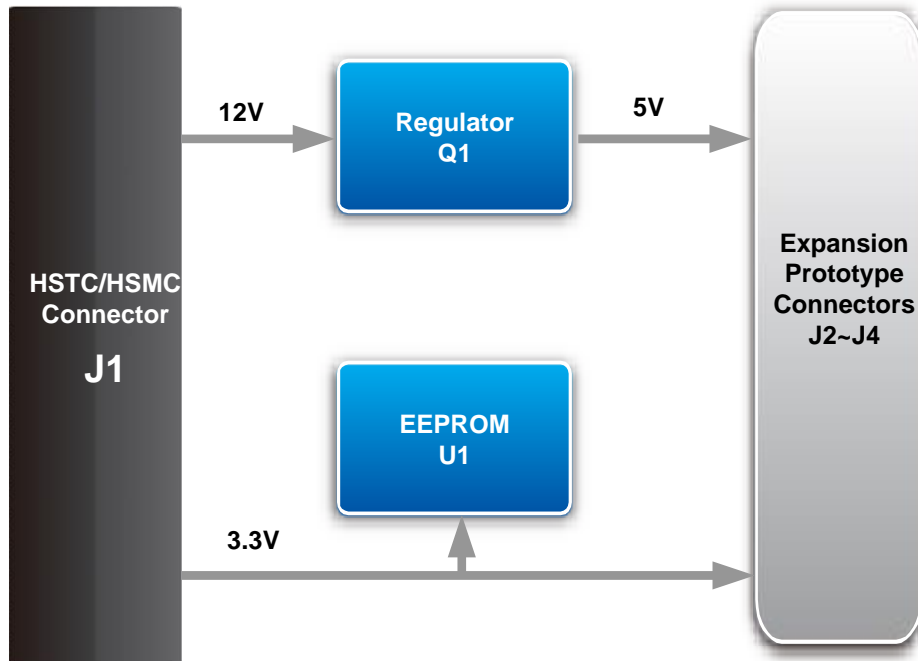

Figure 3.7 THDB-HTG board power distribution diagram.

This chapter illustrates how to use the THDB-HTG board to a HSMC-interfaced host board.

Connecting THDB-HTG Board to a Cyclone III Starter Board

This section describes how to use the THDB-HTG board with a Cyclone III Starter Board.

Figure 4.1 illustrates how the THDB-HTG board is connected to the Cyclone III starter board. Users need to pay extra attention to the following two points:

1. Observe the orientation of the HSMC connector when connecting the THDB-HTG to the Cyclone III Starter Board.
2. Note that there are two LVDS pairs on the HSMC connector: the HSMC_CLK_p1/n1 (form a close loop via R3) and HSMC_CLKIN_p2/n2 (form a close loop via R4). Therefore, using any one of the signal in a LVDS pair under single-ended mode will prevent users from using the other signal in the same pair.

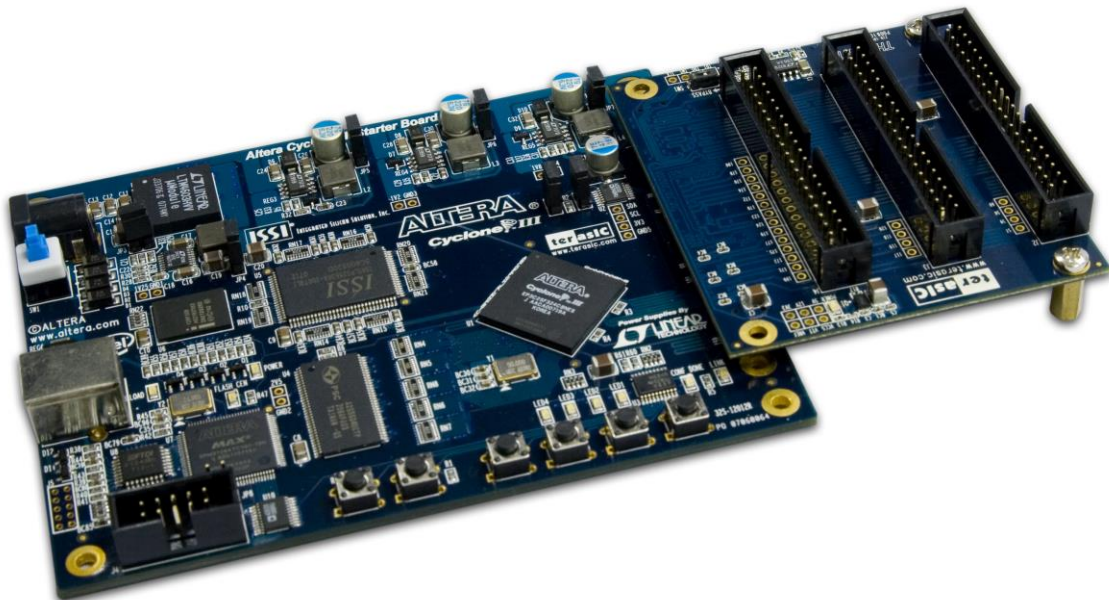

Figure 4.1 Connecting the THDB-HTG board to the Cyclone III starter board

Connecting THDB-HTG Board to Altera DE3 Board

This section describes how to use the THDB-HTG board with Altera DE3 Board.

Figure 4.2 illustrates how the THDB-HTG board is connected to the Altera DE3 board. Users need to pay extra attention to the following three points:

1. THDB-HTG board can be connected to any of the HSTC connectors J1, J3, J5, and J7 on the DE3 board.
2. The JTAG Switch on the THDB-HTG board **MUST** be switched to “Bypass” position, or the FPGA device on DE3 board will not be detected.
3. Users can use DE3_System_builder to create Quartus II project. Please refer to Figure 3.2 for the corresponding signal names.

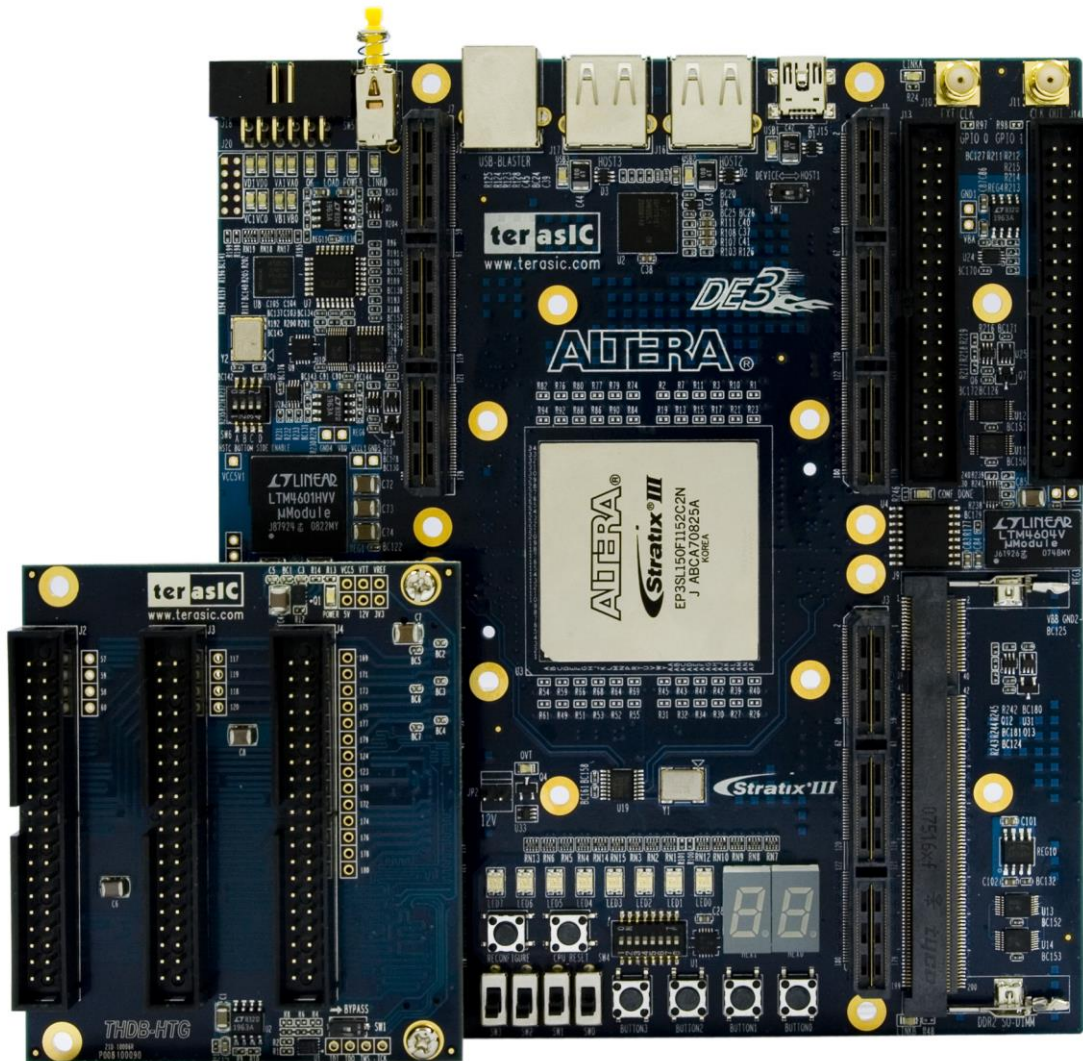

Figure 4.2 Connecting the THDB-HTG board to the Cyclone III starter board

Revision History

Date	Change Log
JAN 04, 2009	Initial Version
Oct 20, 2009	Added Cyclone III Starter Board HSMC Connector section
April 08, 2010	Modified pin names for Cyclone III Starter Board HSMC Connector section
Dec 24, 2010	Corrected Table 3.1 Pin Mapping
July 20,2011	Change cover page
2017.04	Modify Section 1.5 and Figure 3.3
2018.12	Modify Figure 2.1, Figure 3.4 and Figure 3.5

Always Visit THDB-HTG Webpage for New Main board

We will be continuing providing interesting examples and labs on our THDB-HTG webpage. Please visit www.altera.com or HTG.terasic.com for more information.

Mouser Electronics

Authorized Distributor

Click to View Pricing, Inventory, Delivery & Lifecycle Information:

[Terasic:](#)

[P0033](#)