

Keysight N7010A Active Termination Adapter

User's Guide



Notices

© Keysight Technologies, Inc. 2015-2016, 2020, 2021

No part of this manual may be reproduced in any form or by any means (including electronic storage and retrieval or translation into a foreign language) without prior agreement and written consent from Keysight Technologies, Inc. as governed by United States and international copyright laws.

Manual Part Number

N7010-97003

Edition

Fifth edition, November 2021

Published by:
Keysight Technologies, Inc.
1400 Fountaingrove Parkway
Santa Rosa, CA, 95403

Warranty

The material contained in this document is provided “as is,” and is subject to being changed, without notice, in future editions. Further, to the maximum extent permitted by applicable law, Keysight disclaims all warranties, either express or implied, with regard to this manual and any information contained herein, including but not limited to the implied warranties of merchantability and fitness for a particular purpose. Keysight shall not be liable for errors or for incidental or consequential damages in connection with the furnishing, use, or performance of this document or of any information contained herein. Should Keysight and the user have a separate written agreement with warranty terms covering the material in this document that conflict with these terms, the warranty terms in the separate agreement shall control.

Technology Licenses

The hardware and/or software described in this document are furnished under a license and may be used or copied only in accordance with the terms of such license.

Restricted Rights Legend

U.S. Government Rights. The Software is "commercial computer software," as defined by Federal Acquisition Regulation ("FAR") 2.101. Pursuant to FAR 12.212 and 27.405-3 and Department of Defense FAR Supplement ("DFARS") 227.7202, the U.S. government acquires commercial computer software under the same terms by which the software is customarily provided to the public. Accordingly, Keysight provides the Software to U.S. government customers under its standard commercial license, which is embodied in its End User License Agreement (EULA), a copy of which can be found at <http://www.keysight.com/find/sweula>. The license set forth in the EULA represents the exclusive authority by which the U.S. government may use, modify, distribute, or disclose the Software. The EULA and the license set forth therein, does not require or permit, among other things, that Keysight: (1) Furnish technical information related to commercial computer software or commercial computer software documentation that is not customarily provided to the public; or (2) Relinquish to, or otherwise provide, the government rights in excess of these rights customarily provided to the public to use, modify, reproduce, release, perform, display, or disclose commercial computer software or commercial computer software documentation. No additional government requirements beyond those set forth in the EULA shall apply, except to the extent that those terms, rights, or licenses are explicitly required from all providers of commercial computer software pursuant to the FAR and

the DFARS and are set forth specifically in writing elsewhere in the EULA. Keysight shall be under no obligation to update, revise or otherwise modify the Software. With respect to any technical data as defined by FAR 2.101, pursuant to FAR 12.211 and 27.404.2 and DFARS 227.7102, the U.S. government acquires no greater than Limited Rights as defined in FAR 27.401 or DFAR 227.7103-5 (c), as applicable in any technical data.

Safety Notices

CAUTION

A **CAUTION** notice denotes a hazard. It calls attention to an operating procedure, practice, or the like that, if not correctly performed or adhered to, could result in damage to the product or loss of important data. Do not proceed beyond a **CAUTION** notice until the indicated conditions are fully understood and met.

WARNING

A **WARNING** notice denotes a hazard. It calls attention to an operating procedure, practice, or the like that, if not correctly performed or adhered to, could result in personal injury or death. Do not proceed beyond a **WARNING** notice until the indicated conditions are fully understood and met.

Contents

1	General Information / 5
	Connecting the N7010A / 6
	Using the N7010A / 8
	N7010A's Low Noise Floor / 11
	Avoiding Costly Repairs / 12
	Safety Information / 14
	Inspecting the N7010A / 17
	Cleaning the N7010A / 17
	Returning the Product for Service / 18
	Contacting Keysight Technologies / 19
2	Specifications and Characteristics / 21
	Specifications and Characteristics / 22
	N7010A Dimensions / 26
3	Performance Verification / 27
	Test 1. Bandwidth / 28
	Test 2. Input Resistance at DC / 34
	Performance Test Record / 37
	Index

Contents

1 General Information

Connecting the N7010A	6
Using the N7010A	8
N7010A's Low Noise Floor	11
Avoiding Costly Repairs	12
Safety Information	14
Inspecting the N7010A	17
Cleaning the N7010A	17
Returning the Product for Service	18
Contacting Keysight Technologies	19

The N7010A active termination adapter is a 30 GHz single-ended adapter featuring a user adjustable common termination voltage (V_{term}) and extremely low noise performance. The N7010A is ideal for high SNR (low noise) measurements for standards such as:

- HDMI 2.0,
- DisplayPort, and
- MIPI M-PHY Gear 3/4.

CAUTION

Before using the N7010A, refer to **"Safety Information"** on page 14. Handle the N7010A with care and refer to the safety notices in this manual. Avoid any mechanical shocks to this product in order to guarantee accurate performance and protection.

CAUTION

The maximum allowable input to the N7010A is $\pm 4V$.

Connecting the N7010A

Compatible Oscilloscopes

The N7010A is compatible with the Keysight oscilloscopes shown in [Table 1](#). The table also lists the minimum required firmware version for the oscilloscope. The N7010A is designed for oscilloscopes with 50 Ω AutoProbe II interface channel inputs. The AutoProbe II interface also provides power to the probe.

Table 1 Compatible Oscilloscopes and Support

Infiniium Oscilloscopes	Required Firmware Version
Z-Series	≥ 5.30
V-Series	
90000Q	
90000X	$\geq 5.50.0031$
UXR-Series 3.5 mm models	≥ 5.30
UXR-Series 1 and 1.85 mm models (with N2852A adapter)	$\geq 11.15.00001$

NOTE

Is Your Oscilloscope Software Up-to-Date? Keysight periodically releases software updates to support your probe, fix known defects, and incorporate product enhancements. To download the latest firmware, go to www.keysight.com and search for your oscilloscope's topic. Click on the "Drivers, Firmware & Software" tab.

N7010A Input Connection

The N7010A comes with a 2.9 mm precision connector and a removable 3.5 mm connector saver as shown in [Figure 1](#) on page 7. The 2.9 mm connector is compatible with 2.92 mm, 3.5 mm, and SMA connectors but can be damaged by mating to low-quality SMA connectors. You can also connect SMP cables using an adapter (*not provided*).

The relatively inexpensive connector saver protects the N7010A's 2.9 mm connector from wear caused when repeatedly making cable connections or from mating with low-quality SMA connectors.

CAUTION

Avoid costly repairs that are caused from making improper connections to the 2.9 mm precision RF input connector. Always properly align any mating connection *before* tightening the connection to the specified torque.

CAUTION

Torque all cables and adapter connections to the 2.9 mm connector to 8 in-lbs (90 N-cm).

CAUTION

Torque all cables and adapter connections to the 3.5 mm connector saver to 8 in-lbs (90 N-cm).

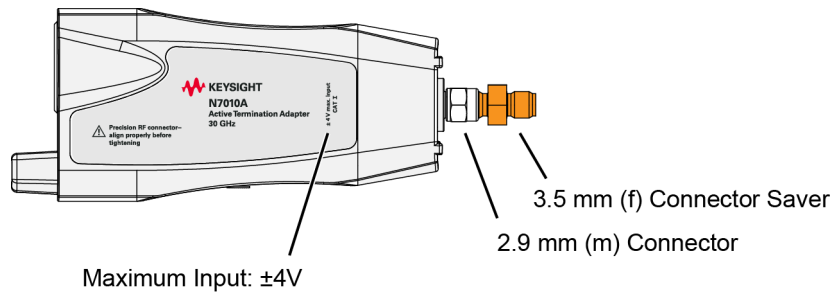

Figure 1 N7010A with Supplied Connector Saver

Using the N7010A

This section describes how to use the N7010A active termination adapter. **Figure 2** shows a block diagram of the N7010A connected to the oscilloscope. The V_{off} and V_{term} controls are supplied from the oscilloscope via the AutoProbe II connector.

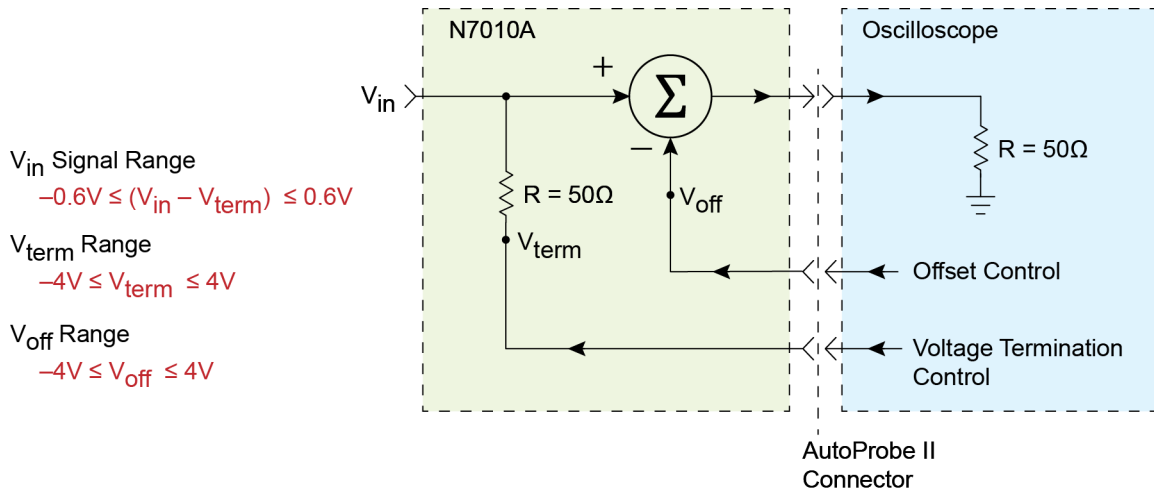

Figure 2 Simplified Function Diagram

CAUTION

To avoid damaging the N7010A, the maximum low frequency (LF) input voltage must not exceed $\pm 8\text{V}$. LF is defined as DC to approximately 50 kHz, and AC is defined as greater than approximately 50 kHz.

V_{term} Control

The V_{term} control is used to allow the 50 ohm input of the N7010A to be terminated to a voltage rather than to ground, which is required by some devices under tests (DUTs). V_{term} can be set anywhere from -4V to $+4\text{V}$, however V_{in} must never be more than 0.6V away from V_{term} .

To set the V_{term} voltage, perform the following steps on the oscilloscope:

- 1 Click **Setup** > **Probe Configuration** to open the Probe Configuration dialog box.

- 2 Select the N7010A tab.
- 3 In the dialog box's Probe System field, click **Options** to open the Probe dialog box.
- 4 Set the Termination Voltage.

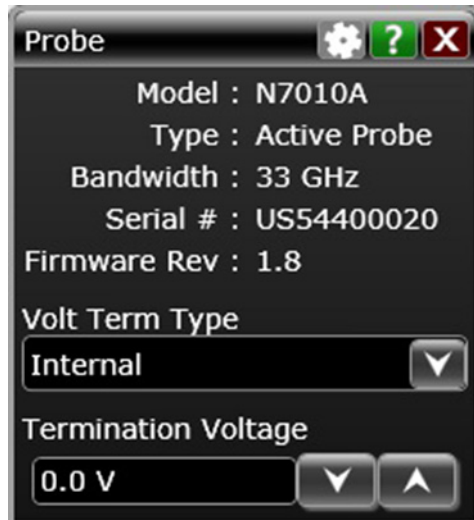

Figure 3 Probe Dialog Box

V_{off} Control

The V_{off} control allows the N7010A to subtract the DC voltage component from V_{in} thereby allowing the N7010A output to be centered around ground.

To set the V_{off} control, perform the following steps on the oscilloscope:

- 1 Click **Setup > Probe Configuration** to open the Probe Configuration dialog box.
- 2 Select the N7010A tab.
- 3 In the dialog box's Probe System field, click **Probe Offset** and enter the required offset voltage.

Maximum Signal Input

To avoid distortion, the input signal to the N7010A must and be within the following limits:

$$-600 \text{ mV} \leq (V_{\text{input}} - V_{\text{termination}}) \leq +600 \text{ mV}$$

The maximum allowable input signal ($1.2 V_{\text{pp}}$) occurs when V_{in} is centered on V_{term} and V_{off} is adjusted to remove the DC component of V_{in} , which means the signal into the oscilloscope is centered around ground.

NOTE

V_{in} is the voltage at the input of the N7010A. If the source driving the N7010A has a non-zero output impedance then V_{term} will interact with V_{in} .

CAUTION

To avoid damaging the N7010A, the maximum low frequency (LF) voltage on the input should not exceed $\pm 8\text{V}$. To avoid damaging the oscilloscope input, the maximum AC voltage should not exceed $5V_{\text{rms}}$ (which is 0.5W into 50 ohms).

N7010A's Low Noise Floor

With the N7010A's low attenuation ratio setting (1.16:1), the adapter has an extremely lower noise floor. The following two pictures compare two eye diagrams for the same MIPI M-PHY Gear 3 data rate signal at 5.8304 Gb/s. The amplitude swing is 140 mV_{pp}. **Figure 4** shows the signal connected directly to the Infiniium oscilloscope's channel input *without* using a N7010A. **Figure 5** shows the same signal connected to the oscilloscope *through* the N7010A. Notice that the N7010A doesn't inherently contribute noise.

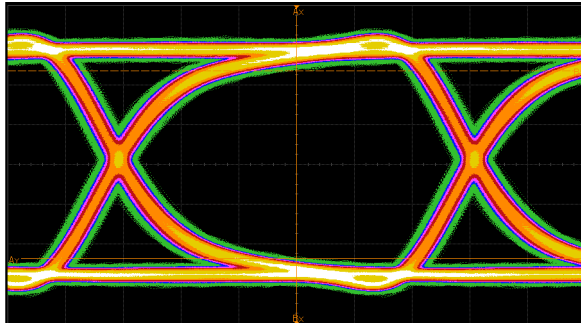

Figure 4 Direct Signal Connect to Infiniium Scope *Without* N7010A

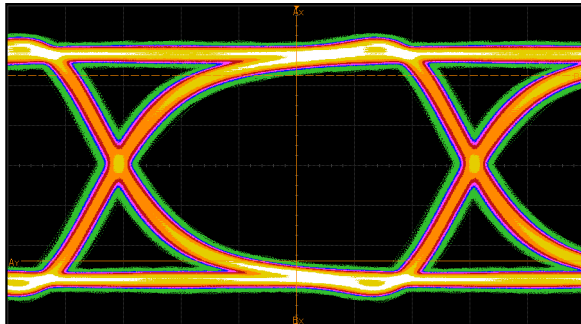

Figure 5 Signal Connected to Infiniium Scope *Through* N7010A

Avoiding Costly Repairs

When connecting or using the N7010A, use caution to avoid damaging the oscilloscope's channel input circuits due to electrostatic discharge (ESD).

CAUTION

When the N7010A is connected to the oscilloscope, the oscilloscope's channel input circuits can be damaged by electrostatic discharge (ESD). Avoid applying static discharges to the N7010's input. Prior to energizing and connecting any accessory cable to the N7010A, momentarily short the center and outer conductors of the cable together. Be sure that the instrument is properly earth-grounded to prevent buildup of static charge. Wear a wrist-strap or heel-strap.



Figure 6 on page 13 shows an example of a static-safe work station using two types of ESD protection:

- Conductive table-mat and wrist-strap combination.
- Conductive floor-mat and heel-strap combination.

Both types, when used together, provide a significant level of ESD protection. Of the two, only the table-mat and wrist-strap combination provides adequate ESD protection when used alone. To ensure user safety, the static-safe accessories must provide at least 1 M Ω of isolation from ground. Purchase acceptable ESD accessories from your local supplier.

WARNING

These techniques for a static-safe work station should not be used when working on circuitry with a voltage potential greater than 500 volts.

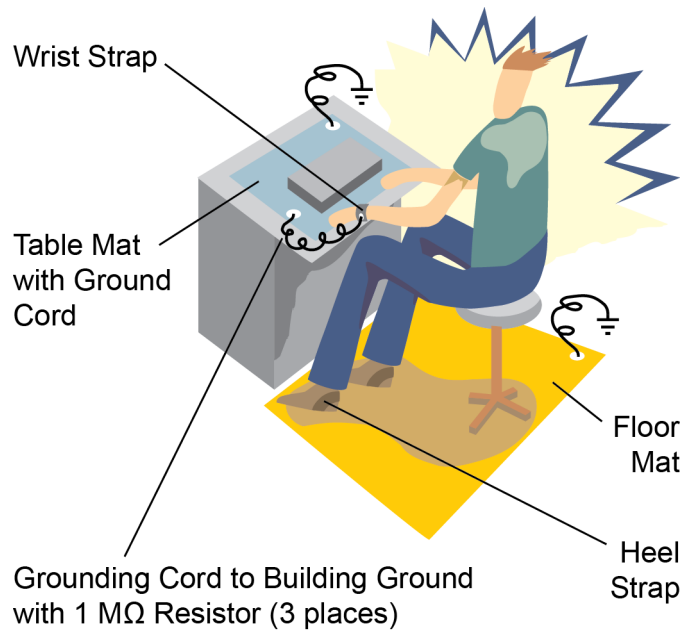

Figure 6 ESD Workstation

Safety Information



This manual provides information and warnings essential for operating the N7010A in a safe manner and for maintaining it in safe operating condition. Before using this equipment and to ensure safe operation and to obtain maximum performance from the probe, carefully read and observe the following warnings, cautions, and notes.

This product has been designed and tested in accordance with accepted industry standards, and has been supplied in a safe condition. The documentation contains information and warnings that must be followed by the user to ensure safe operation and to maintain the product in a safe condition.

Note the external markings on the probe that are described in this document.

WARNING

To avoid personal injury and to prevent fire or damage to this product or products connected to it, review and comply with the following safety precautions. Be aware that if you use this probe assembly in a manner not specified, the protection this product provides may be impaired.

WARNING

Use Only Grounded Instruments.

Do not connect the probe's ground lead to a potential other than earth ground. Always make sure the probe and the oscilloscope are grounded properly.

WARNING

Connect and Disconnect Properly.

Connect the probe to the oscilloscope and connect the ground lead to earth ground before connecting the probe to the circuit under test. Disconnect the probe input and the probe ground lead from the circuit under test before disconnecting the probe from the oscilloscope.

WARNING

Do Not Operate Without Covers. To avoid electrical shock or fire hazard, do not operate this probe with the covers removed.

WARNING

Do Not Operate in Wet / Damp Conditions.

To avoid electrical shock, do not operate this probe in wet or damp conditions.

WARNING

Do Not Operate in an Explosive Atmosphere.
To avoid injury or fire hazard, do not operate this probe in an explosive atmosphere.

WARNING

Avoid Exposed Circuit. To avoid injury, remove jewelry such as rings, watches, and other metallic objects. Do not touch exposed connections and components when power is present.

WARNING

For Indoor Use Only. Only use this probe indoors.

WARNING

Do Not Operate With Suspected Failures. If you suspect there is damage to this probe, have it inspected by a qualified service personne.

Concerning the Oscilloscope or Voltage Measuring Instrument to Which the Probe is Connected

WARNING

Whenever it is likely that the ground protection is impaired, you must make the instrument inoperative and secure it against any unintended operation.

WARNING

If you energize the instrument by an auto transformer (for voltage reduction or mains isolation), the ground pin of the input connector terminal must be connected to the earth terminal of the power source.

WARNING

Before turning on the instrument, you must connect the protective earth terminal of the instrument to the protective conductor of the (mains) power cord. The mains plug shall only be inserted in a socket outlet provided with a protective earth contact. You must not negate the protective action by using an extension cord (power cable) without a protective conductor (grounding). Grounding one conductor of a two-conductor outlet is not sufficient protection.

WARNING

Only fuses with the required rated current, voltage, and specified type (normal blow, time delay, etc.) should be used. Do not use repaired fuses or short-circuited fuse holders. To do so could cause a shock or fire hazard.

WARNING

Capacitors inside the instrument may retain a charge even if the instrument is disconnected from its source of supply.

Inspecting the N7010A

- Inspect the shipping container for damage.

Keep the damaged shipping container or cushioning material until the contents of the shipment have been checked for completeness and the probe has been checked mechanically and electrically.

- Check the accessories.
- If the contents are incomplete or damaged, notify your Keysight Technologies Sales Office.
- Inspect the **N7010A**. If there is mechanical damage or defect, or if the **N7010A** does not operate properly or pass calibration tests, notify your Keysight Technologies Sales Office.

If the shipping container is damaged, or the cushioning materials show signs of stress, notify the carrier as well as your Keysight Technologies Sales Office. Keep the shipping materials for the carrier's inspection. The Keysight Technologies office will arrange for repair or replacement at Keysight Technologies' option without waiting for claim settlement.

Cleaning the N7010A

Disconnect the N7010A from the oscilloscope and clean the N7010A with a soft cloth dampened with a mild soap and water solution. Make sure that the N7010A is completely dry before reconnecting it to an oscilloscope. Avoid using abrasive cleaners and chemicals containing benzene or similar solvents.

Returning the Product for Service

If the N7010A is found to be defective we recommend sending it to an authorized service center for all repair and calibration needs. Perform the following steps before shipping the probe back to Keysight Technologies for service.

- 1 Contact your nearest Keysight sales office for information on obtaining an RMA number and return address.
- 2 Write the following information on a tag and attach it to the malfunctioning equipment.
 - Name and address of owner
 - Product model number (for example, N7010A)
 - Product Serial Number (for example, USXXXXXXXX)

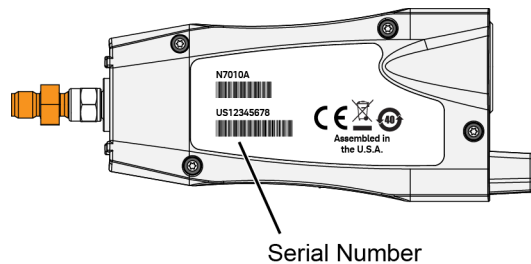

Figure 7 Location of Serial Number

- Description of failure or service required.

NOTE

Include probing and browsing heads if you feel the probe is not meeting performance specifications or a yearly calibration is requested.

- 3 Protect the probe by wrapping in plastic or heavy paper.
- 4 Pack the probe in the original carrying case or if not available use bubble wrap or packing peanuts.
- 5 Place securely in sealed shipping container and mark container as "FRAGILE".

NOTE

If any correspondence is required, refer to the product by serial number and model number.

Contacting Keysight Technologies

For technical assistance, contact your local Keysight Call Center.

- In the Americas, call 1 (800) 829-4444
- In other regions, visit <http://www.keysight.com/find/assist>
- Before returning an instrument for service, you must first call the Call Center at 1 (800) 829-4444.

1 General Information

2 Specifications and Characteristics

Specifications and Characteristics **22**
N7010A Dimensions **26**

The tables in this chapter list the specifications and characteristics for the N7010A adapter. Bandwidth and input resistance at DC are warranted specifications for the N7010A.

Connect the N7010A to a powered-on oscilloscope for at least 20 minutes before any testing to allow the adapter to warm up. Ensure that the environmental conditions do not exceed the adapter's specified limits.

Specifications and Characteristics

Table 2 Electrical Specifications and Characteristics





Item	Characteristics
Bandwidth (-3 dB) *	> 30 GHz (warranted), >32 GHz (typical)
Rise time (10% – 90%)	14.5 ps
Attenuation ratio	1.16:1
Noise with oscilloscope	Refer to "N7010A's Low Noise Floor" on page 11.
V_{term} range	-4V to +4V
V_{term} accuracy	± 2 mV
V_{offset} range	-4V to +4V
Input signal range	$-0.6\text{V} \leq (V_{\text{in}} - V_{\text{term}}) \leq +0.6\text{V}$
Input resistance at DC *	$50\Omega \pm 3\%$
Maximum non-destructive input voltage	$\pm 8\text{V DC to } 50 \text{ kHz}, 5V_{\text{rms}}$ above 50 kHz

* Warranted specification.

Table 3 Environmental Specifications

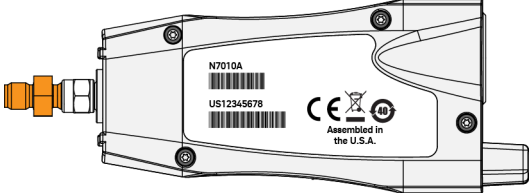
Description	Specification
Temperature	Operating: $-10\text{ }^{\circ}\text{C}$ to $+55\text{ }^{\circ}\text{C}$ Non-operating: $-30\text{ }^{\circ}\text{C}$ to $+70\text{ }^{\circ}\text{C}$
Altitude	Operating: 3,000 m (9,842 feet) Non-operating: 15,300 m (50,196 feet)
Humidity	Operating: 25 – 85% room humidity Non-operating: 25 – 85% room humidity
Pollution Degree	Pollution Degree 2

Table 4 N7010A Safety and Regulatory Information

Description	
	
<p>CAT I</p>	<p>Measurement Category I (CAT I). Measurement category I is for measurements performed on circuits not directly connected to a mains supply. For example, measurements in circuits not derived from a mains supply and specially protected (internal) circuits derived from a mains supply. In the latter case, transient stresses are variable. For that reason, it is required that the transient withstand capability of the equipment is made known to the user.</p>
	<p>This symbol indicates the Environmental Protection Use Period (EPUP) for the product's toxic substances for the China RoHS requirements.</p>
	<p>The CE mark is a registered trademark of the European Community. ISM GRP 1-A denotes the instrument is an Industrial Scientific and Medical Group 1 Class A product. ICES/NMB-001 indicates product compliance with the Canadian Interference-Causing Equipment Standard.</p>
	<p>This product complies with the WEEE Directive (2002/96/EC) marking requirements. The affixed label indicates that you must not discard this electrical/electronic product in domestic household waste. Product Category: With reference to the equipment types in the WEEE Directive Annex I, this product is classed as a "Monitoring and Control instrumentation" product. Do not dispose in domestic household. To return unwanted products, contact your local Keysight office, or refer to www.keysight.com for more information.</p>

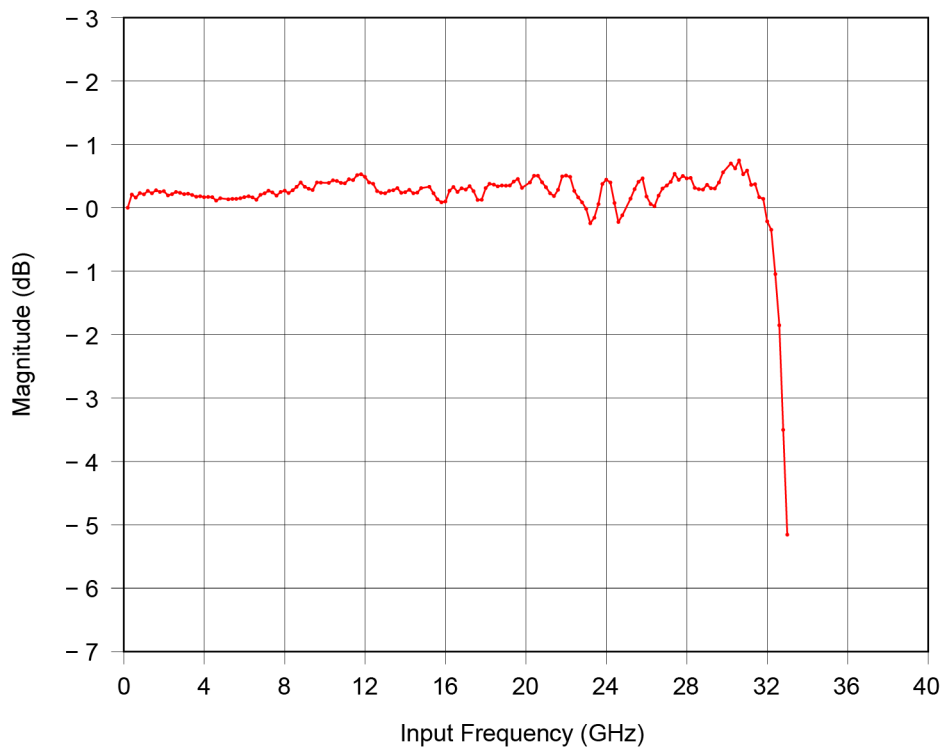

Figure 8 Typical N7010A Bandwidth

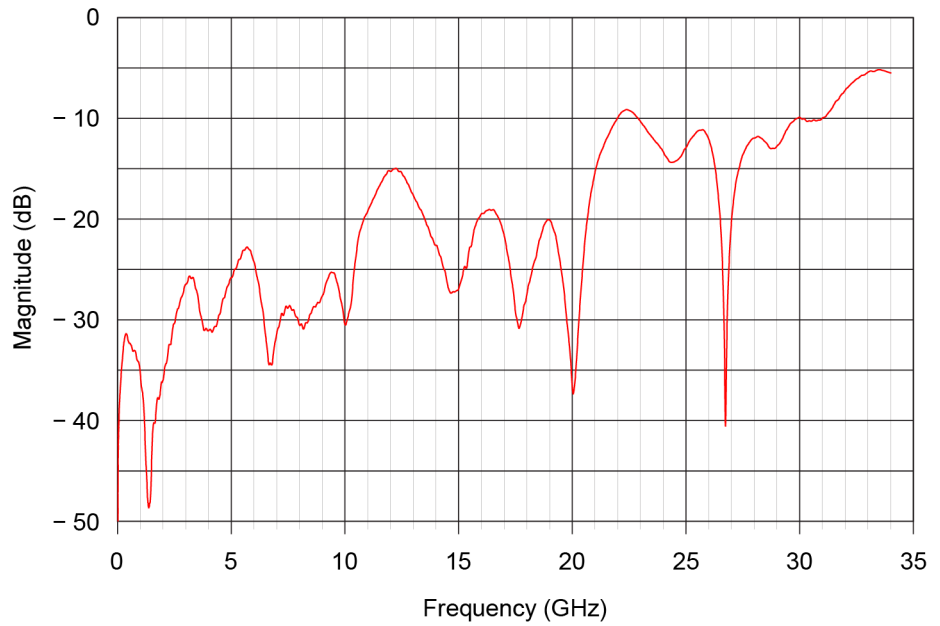

Figure 9 N7010A Typical Input Return Loss

N7010A Dimensions

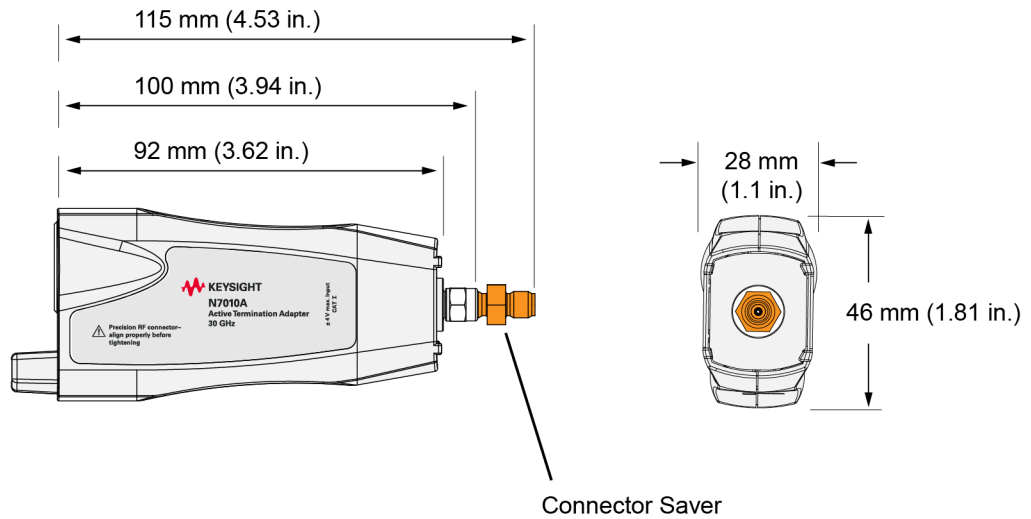

Figure 10 N7010A Dimensions with Connector Saver

3 Performance Verification

Test 1. Bandwidth 28

Test 2. Input Resistance at DC 34

Performance Test Record 37

This chapter tests that the N7010A meets its specified bandwidth and input resistance at DC

CAUTION

Electrostatic discharge (ESD) can quickly and imperceptibly damage or destroy high performance probes, resulting in costly repairs. Always wear a wrist strap when handling probe components and ensure that cables are discharged before being connected.

CAUTION

Ensure that the input voltage to the oscilloscope never exceeds $\pm 4V$.

NOTE

Allow the N7010A termination adapter to warm up for at least 20 minutes.

NOTE

Let the oscilloscope warm up before testing. The oscilloscope under test must be warmed up (with the oscilloscope application running) for at least 30 minutes prior to the start of any performance test.

Test 1. Bandwidth

Bandwidth for the N7010A Active Termination Adapter is specified when used with a Keysight Infiniium Oscilloscope that has a 32 GHz bandwidth. The procedure in this section is very similar to the procedure described in the service manual for any of the 32 GHz Infiniium oscilloscopes except that the bandwidth need only be tested at the oscilloscope's 50 mV/div setting.

This procedure tests that the bandwidth of the N7010A and oscilloscope combination is not more that -3 db at 30 GHz.

Recommended Test Interval

The recommended test interval is 1 year.

Table 5 Required Test Equipment

Test Equipment	Critical Specification	Model Number
Oscilloscope	Supported Oscilloscope	Infiniium 90000Q series, V series, and Z series oscilloscopes.
Microwave CW Generator	Maximum Frequency ≥ 32 GHz Power range: -20 dBm to +16 dBm into 50 Ω Output resistance = 50 Ω	Keysight E8257D with Opt 540 or Opt 567
Power Splitter	Two Resistor Power Splitter Maximum frequency ≥ 30 GHz	Keysight 11667C
Power Meter	Keysight P-series with power sensor compatibility	Keysight N1912A
Power Sensor	Maximum Frequency ≥ 30 GHz Power range: -24 dBm to +23 dBm	Keysight N1922A
Microwave Cable	50 Ω Characteristic Impedance 2.4 mm (m) to 2.4 mm (m) SMA connectors Maximum frequency ≥ 30 GHz	Keysight N5180-60204
Adapter	2.4 mm (m) to 3.5 mm (m) (qty. 1)	Keysight 11901A
Adapter	2.4 mm (m) to 3.5 mm (f) (qty. 1)	Keysight 11901C
Connector Saver	3.5 mm (f)-(f), shipped with and attached to the N7010A.	Keysight 5061-5311

Procedure

- 1 Turn on the power meter and preset the power meter.
- 2 Ensure that the power sensor is disconnected from any source and zero the power meter.
- 3 Connect the power sensor to the power meter's Power Ref connector and calibrate the meter.
- 4 Set up the power meter to display measurements in units of Watts.
- 5 Connect the test setup as shown in **Figure 11**. Do not use any additional cabling or adapters.
 - a Remove any connector saver that is installed on the oscilloscope's Channel 1.
 - b Connect the N7010A to Channel 1. The N7010A should have its supplied 3.5 mm connector saver installed.

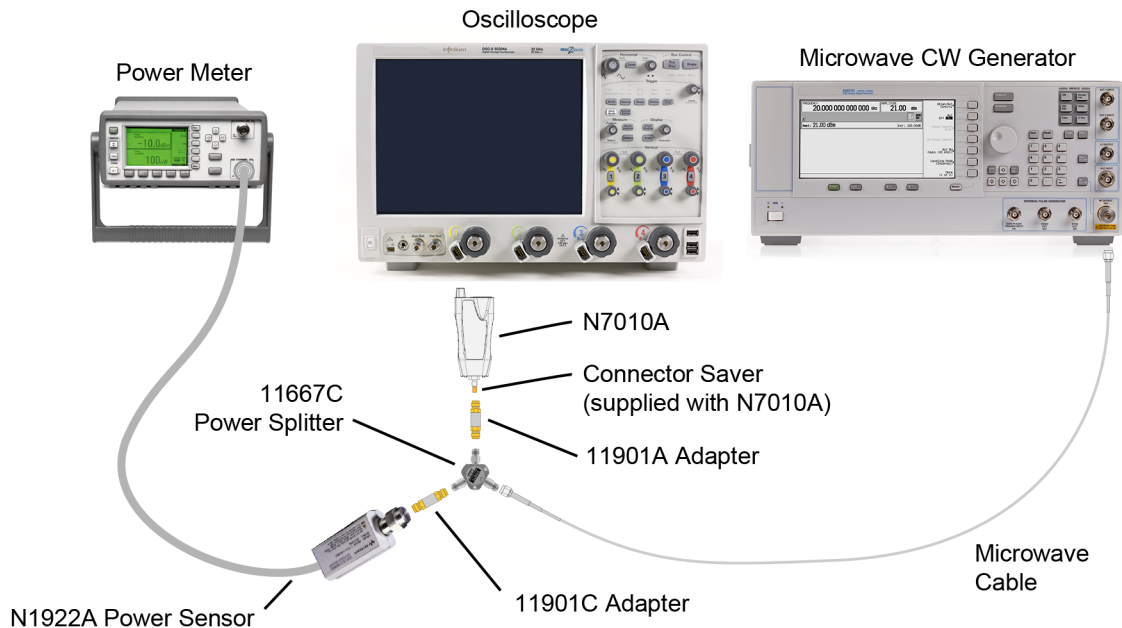

Figure 11 Bandwidth Test Setup

- c Use an 11901A adapter to connect the N7010A to one of the 11667C power splitter's outputs.
- d Use an 11901C adapter to connect the power sensor to the power splitter's remaining output.
- e Connect the microwave cable to the power splitter's input.
- f Tighten all 2.4 mm and 3.5 mm connectors to 8 in-lbs (90 N-cm).

6 On the oscilloscope, press **[Default Setup]** and configure the following settings:

Channel 1: ON
 Channels 2, 3, 4: OFF
 Vertical scale (Channel 1): 50 mV/div
 Horizontal scale: 16 ns/div (display 8 cycles of a 50 MHz waveform)

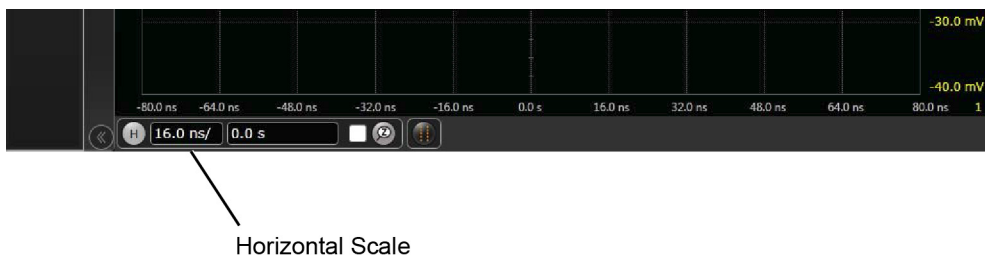

Figure 12 Oscilloscope horizontal scale entry

- 7 Select **Setup > Acquisition** and then set up the acquisition parameters as follows:
 Sin(x)/x Interpolation: Auto
 Averaging: Disabled
 Analog Memory Depth: Automatic
 Analog Sampling rate: 80 GSa/s (maximum)
- 8 Click **Measure > Add Measurement**.
- 9 In the Add Measurement dialog box, select the Vertical RMS measurement as shown in **Figure 13** on page 31.
- 10 In the dialog box, configure the measurement as follows:
 Source: Channel 1
 Measurement Area: Entire Display
 RMS Type: AC

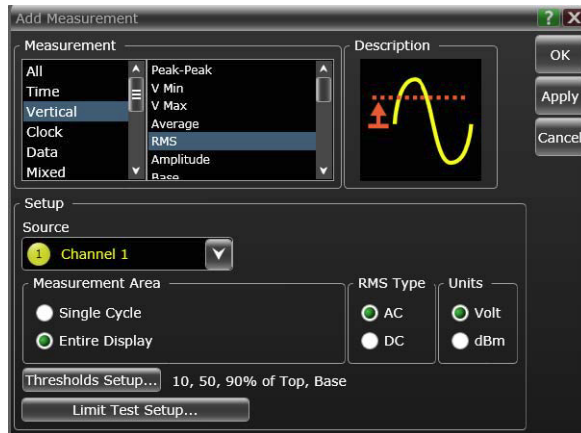

Figure 13 Enter Measurement Info window

- 11 Set the microwave CW generator to the following settings:

Waveform: sine wave
 Frequency: 50 MHz
 Amplitude: 0.4 V_{p-p} (-4 dBm)

NOTE

If your microwave CW generator is unable to produce the recommended amplitude (about 4 on-screen divisions peak-to-peak), then set the generator to the highest value that does not produce a vertically clipped signal on the scope.

- 12 The power meter reads the input power to the scope channel. Convert this measurement to V_{rms} using the following expression. For example, if the power meter reading is 4.0 μW , then $V_{\text{in}} = (4.0 \times 10^{-6} \times 50\Omega)^{1/2} = 14.1 \text{ mV}_{\text{rms}}$.

$$V_{\text{in}} = \sqrt{P_{\text{meas}} \times 50\Omega}$$

- 13 Record the V_{in} value here and in Table 7 on page 37 as V_{in} at 50 MHz.

V_{in} at 50 MHz: _____

- 14 On the oscilloscope, press **[Clear Display]** and locate the oscilloscope’s Mean V_{rms} reading, which is labeled “Mean” in the Measurements display area at the bottom of the screen. Record this value here and in **Table 7** on page 37 as V_{out} at 50 MHz.

V_{out} at 50 MHz: _____

- 15 Calculate the reference gain at 50 MHz using the following expression. Record this value here and in **Table 7** on page 37 as the Calculated Gain at 50 MHz.

$$\text{Gain}_{50 \text{ MHz}} = \frac{V_{out @50 \text{ MHz}}}{V_{in @50 \text{ MHz}}}$$

Gain at 50 MHz: _____

- 16 Change the microwave generator’s frequency to 30 GHz.
- 17 Change the oscilloscope’s horizontal scale to 50 ps/div as shown in **Figure 14** on page 32.

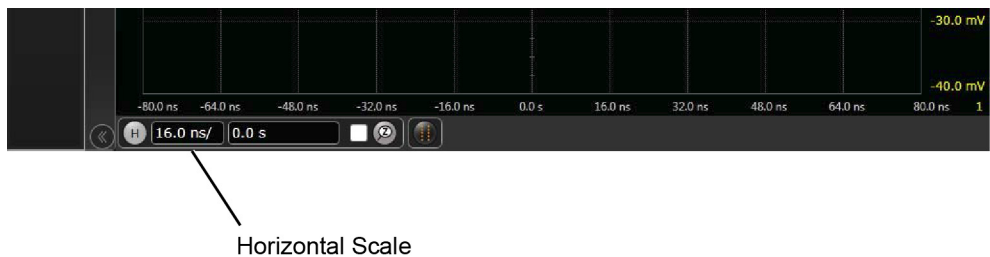

Figure 14 Change Horizontal Scale to 50 ps/division

- 18 The power meter reads the input power to the scope channel. Convert this measurement to V_{rms} using the following expression. For example, if the power meter reading is $4.0 \mu\text{W}$, then $V_{in} = (4.0 \times 10^{-6} \times 50\Omega)^{1/2} = 14.1 \text{ mV}_{rms}$.

$$V_{in} = \sqrt{P_{meas} \times 50\Omega}$$

- 19 Record the V_{in} rms voltage in [Table 7](#) on page 37 as V_{in} at 30 GHz.

V_{in} at 30 GHz: _____

- 20 On the oscilloscope, press **[Clear Display]** and record the “Mean” measurement value in [Table 7](#) on page 37 as V_{out} at 30 GHz.

V_{out} at 30 GHz: _____

- 21 Calculate the gain at the maximum frequency using the following expression. The gain at 50 MHz was calculated in [step 15](#) and recorded in [Table 7](#) on page 37 as the Calculated Gain at 50 MHz.

$$\text{Gain}_{30\text{ GHz}} = 20 \log_{10} \left[\frac{(V_{out @ 30\text{ GHz}})/(V_{in @ 30\text{ GHz}})}{\text{Gain}_{50\text{ MHz}}} \right]$$

For example, if

$V_{out @ 30\text{ GHz}} = 13.825\text{ mV}$,
 $V_{in @ 30\text{ GHz}} = 13.461\text{ mV}$, and
 $\text{Gain @ 50 MHz} = 1.0023$, then:

$$\text{Gain}_{30\text{ GHz}} = 20 \log_{10} \left[\frac{13.825\text{ mV}/13.461\text{ mV}}{1.0023} \right] = 0.212\text{ dB}$$

- 22 Record this value here and in [Table 7](#) on page 37 as the Calculated Gain at 30 GHz. To pass this test, this value must be greater than -3.0 dB.

Gain at 30 GHz: _____

Test 2. Input Resistance at DC

Recommended Test Interval

The recommended test interval is 1 year.

Table 6 Required Test Equipment

Test Equipment	Model Number
Oscilloscope	9000X series Infiniium Oscilloscope. (Or other Infiniium Oscilloscope with an AutoProbe II active probe interface.
Digital voltmeter	Keysight U1272A or any equivalent DVM with similar or better accuracy.
SMA (m) to BNC (f) adapter	Example: Pasternack PE9074 or equivalent
BNC coax	Keysight U2921A-100 or Pasternack PE3067 or any equivalent BNC coax.
BNC (f) to Banana Plug adapter	Pasternack PE9008 or equivalent

Procedure

- 1 Power up the Infiniium oscilloscope and after it boots up attach the N7010A to channel 1. Confirm that the 3.5 mm to 3.5 mm connector saver is attached to the N7010A's input (this connector saver is supplied with the N7010A).
- 2 On the oscilloscope, press [Default Setup].
- 3 In the Probe Configuration menu for Channel 1, select Options for the N7010A block and make sure that the Termination Voltage is set to zero.
- 4 Connect the BNC cable to the N7010A using the SMA (m) to BNC (f) adapter as shown in [Figure 15](#) on page 35.
- 5 Connect the remaining end of the BNC cable to the BNC (f) to banana plug adapter.
- 6 Set the DVM for 2 wire ohms and auto ranging.

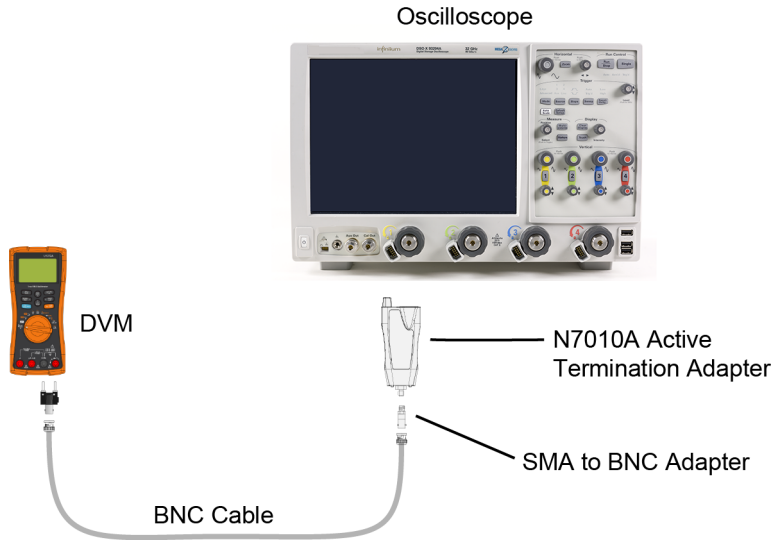

Figure 15 Input Resistance at DC Test Setup

7 Connect the banana plug to the DVM in either orientation. Record the measured input resistance:

Input resistance (R_a): _____

8 Reverse the banana plug connection to the DVM. Record the measured input resistance:

Input resistance (R_b): _____

9 Calculate the average input resistance using the following expression, and record this value here and in [Table 8](#) on page 37.

Average Input Resistance: _____

$$\text{Average Input Resistance} = \frac{R_a + R_b}{2}$$

3 Performance Verification

The average input resistance must meet the 50 ohm $\pm 3\%$ specification:

$$48.5\Omega \leq \text{Average Input Resistance} \leq 51.5\Omega$$

Performance Test Record

Serial #:
 Date:
 Tested by:
 Recommended Next Test Date:

Table 7 Results for Test 1. Bandwidth

Test Frequency	V_{in} (Read on Power Meter)	V_{out} (Read on Oscilloscope)	Calculated Gain (Test Limit ≥ -3 dB)
50 MHz			
30 GHz			

Table 8 Results for Test 2. Input Resistance at DC

Test	Test Limits	Result
Average Input Resistance	$48.5\Omega \leq \text{measured} \leq 51.5\Omega$	

3 Performance Verification

Index

A

accessories
 static-safe, 12
 supplied, 7
altitude, 22
attenuation ratio, 11

B

bandwidth (typical), 24

C

care, N7010A, 5
CAT I, 23
CE mark, 23
cleaning, 17
compatible oscilloscopes, 6
connector saver, 7
connector, input, 6

D

dimensions, N7010A, 26

E

electrical specifications, 22
electrostatic discharge (ESD), 12
environmental specifications, 22
ESD Workstation, 13

F

firmware version, oscilloscope, 6
function diagram, 8

H

humidity, 22

I

input
 connector, 6
 maximum voltage, 5
 return loss (typical), 25
 specified torque, 7
inspecting, 17

K

Keysight Technologies, contacting, 19

L

low frequency input, maximum, 8

M

maximum AC voltage, 10
maximum input voltage, 5
measurement category, 23

N

N7010A
 cable care, 5
 dimensions, 26
 graph of typical bandwidth, 24
 graph of typical input return loss, 25
 inspecting, 17
 noise contribution, 11
 service, 18

O

operation, 8
oscilloscope
 compatibility, 6
 firmware version, 6

P

performance test record, 37
performance verification, 27
Probe Dialog Box, 9

R

repair, 18
returning for service, 18

S

safety, 14
 Considerations, 14
 specifications, 23
 warnings, 14
serial number, location, 18
service, 18
specifications
 and characteristics, 21
 specified input torque, 7
 static-safe accessories, 12

T

temperature, 22

U

using, 8

W

WEEE Directive, 23

