

# RF Characteristics of Si MRM

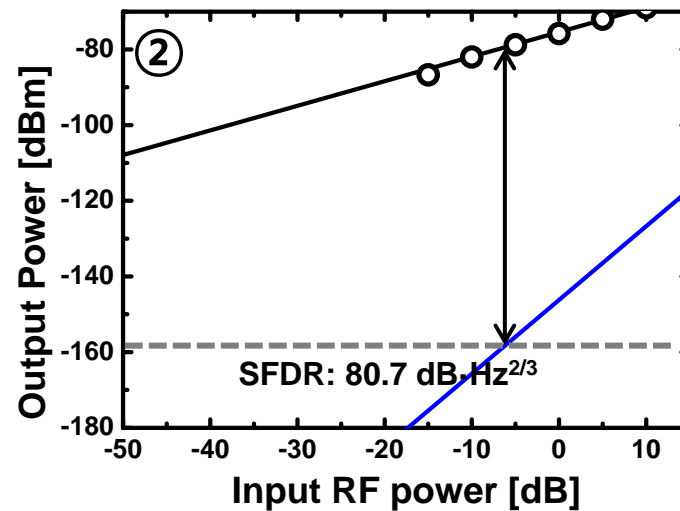

# Add-Drop MRM & Heater

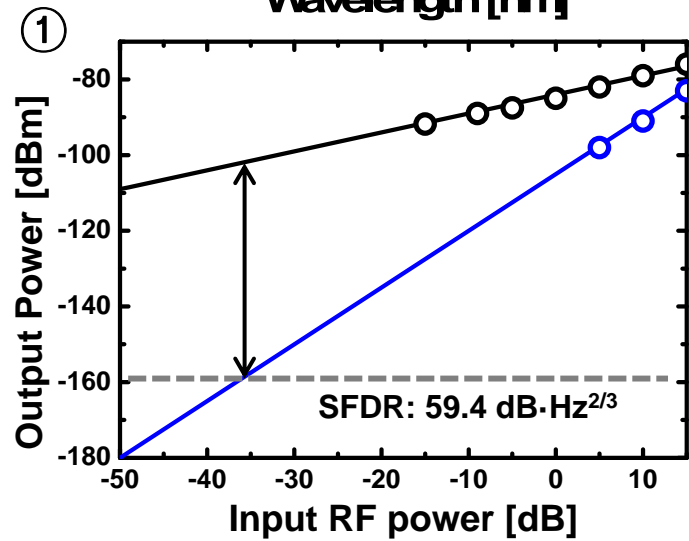
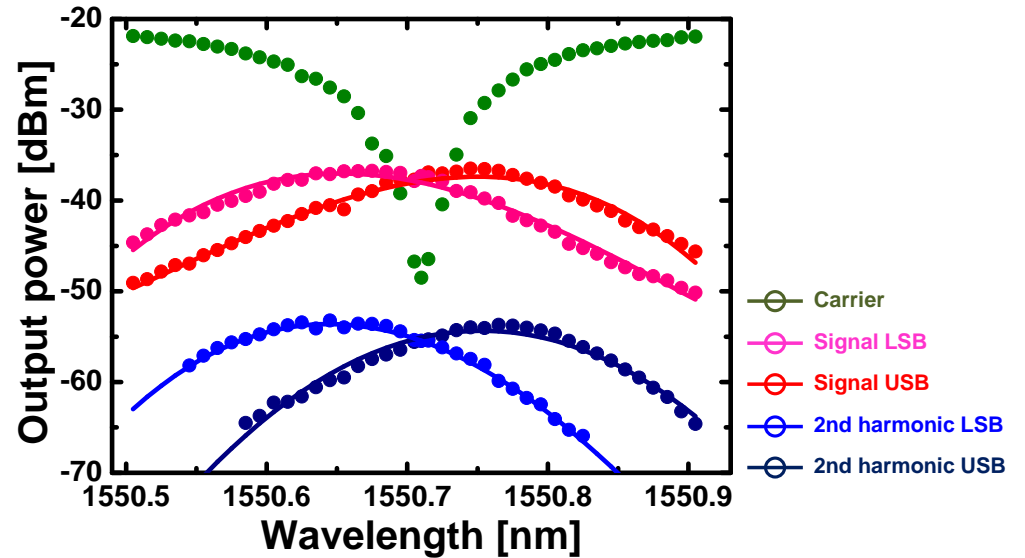
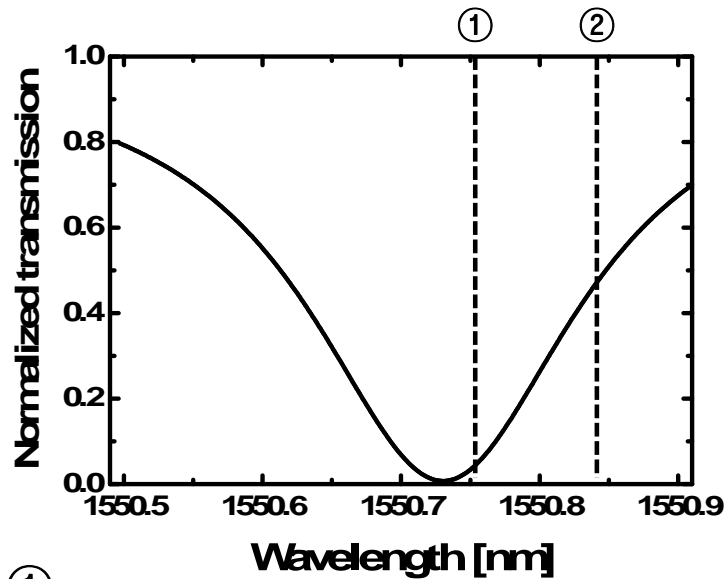
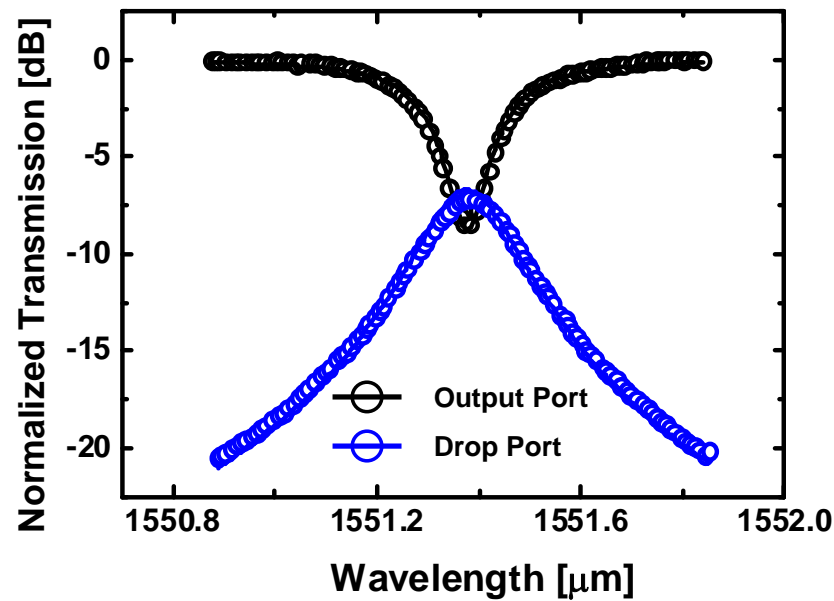
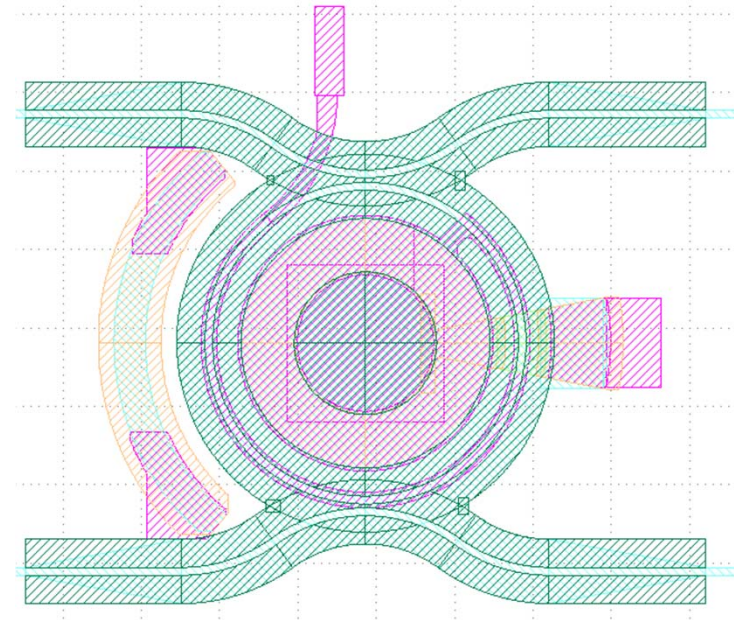
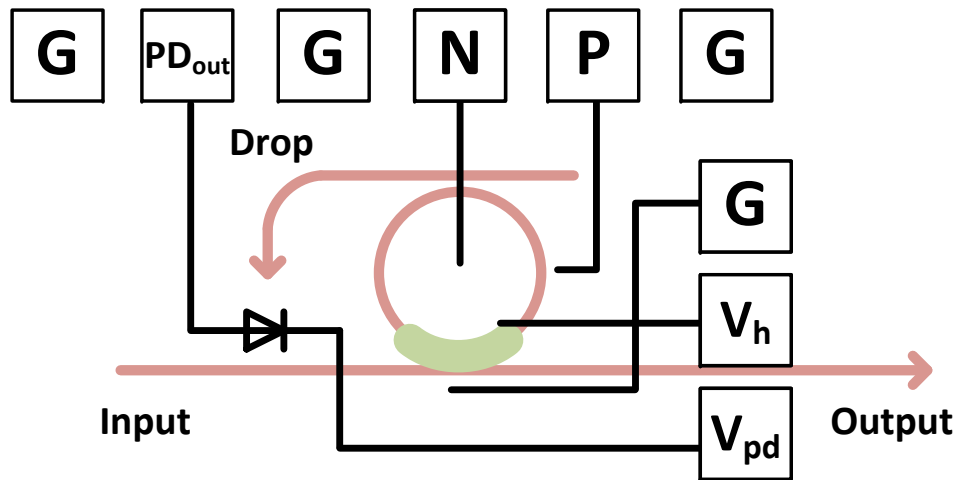

- Metal heater
- Si heater (doped in directly ring waveguide)
- Si heater (doped in surround ring waveguide)